

uni288-review03.jpg

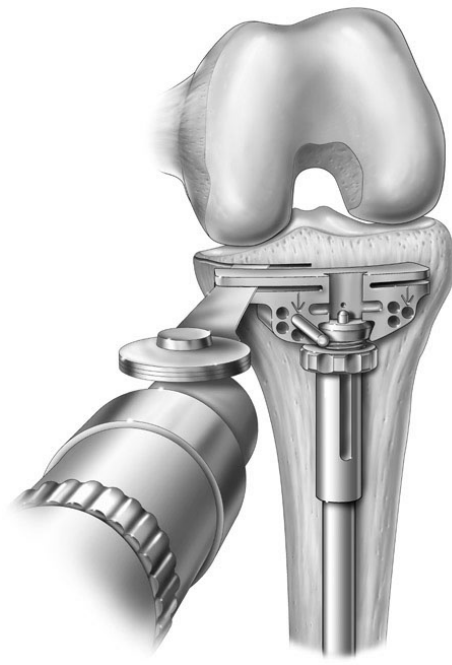

uni291-review01.jpg



uni293-review04.jpg



uni295-review01.jpg

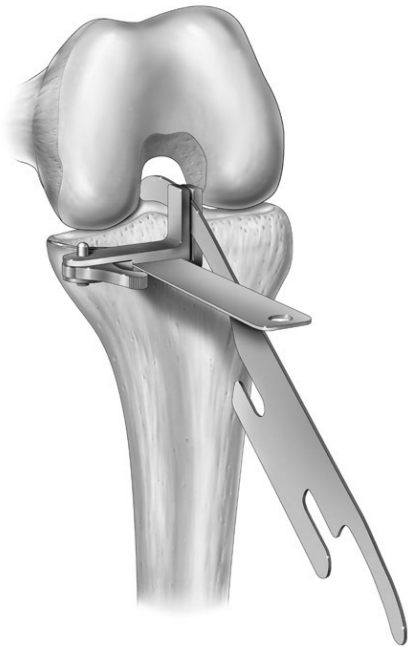

uni296-review02.jpg



uni297-review01.jpg



uni298-review02.jpg



uni299-review01.jpg

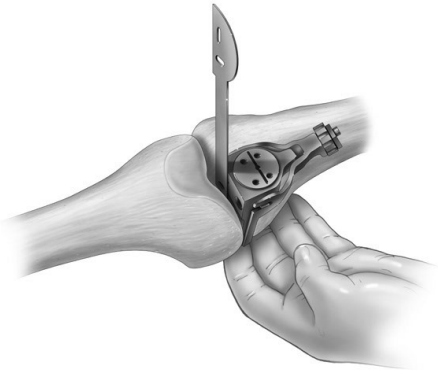

uni300-review03.jpg

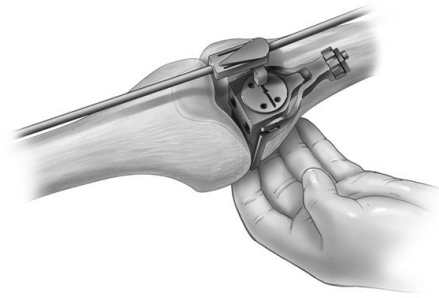

uni303-review01.jpg

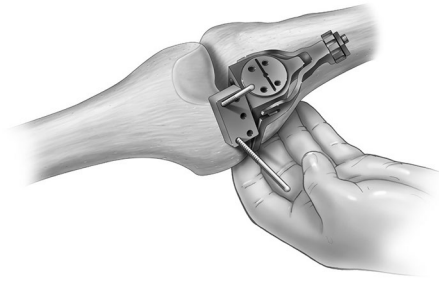

uni305-review01.jpg

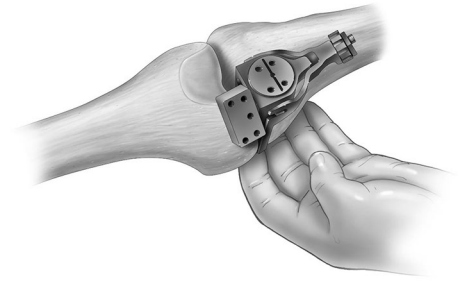

uni306.jpg



uni310-review03.jpg



uni317-review01.jpg



uni320-review01.jpg



uni322-review03.jpg

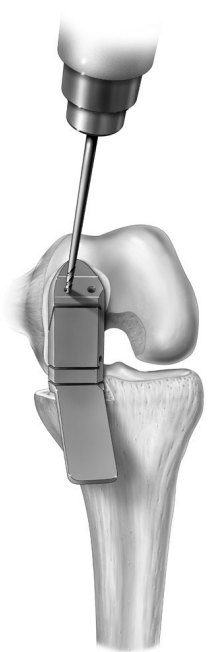

uni323-review01.jpg



uni324m-review01.jpg



uni326m-review01.jpg



uni329-review02.jpg

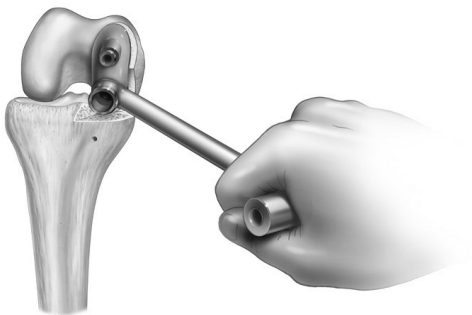

uni331m-review02.jpg

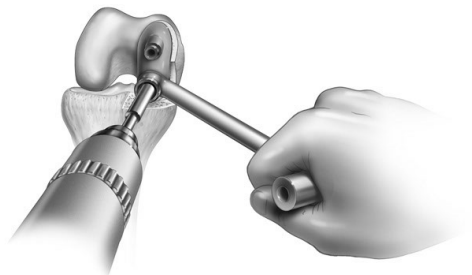

uni334m-review01.jpg



uni335m-review01.jpg

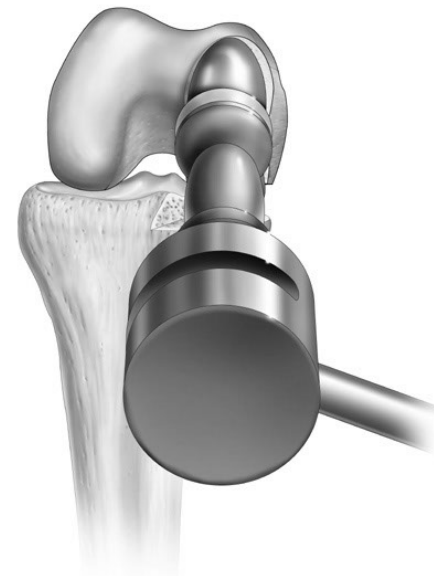

uni336m-review01.jpg



uni339m-review03.jpg

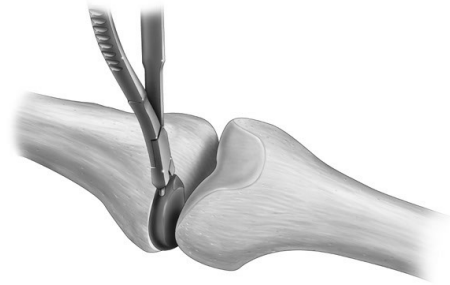

uni341m-review02.jpg

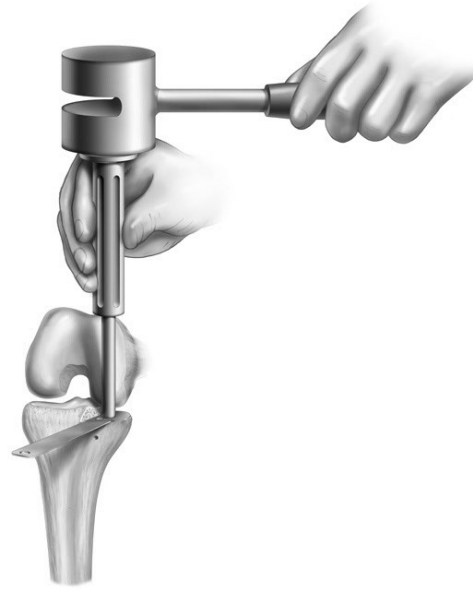

uni343m-review01.jpg

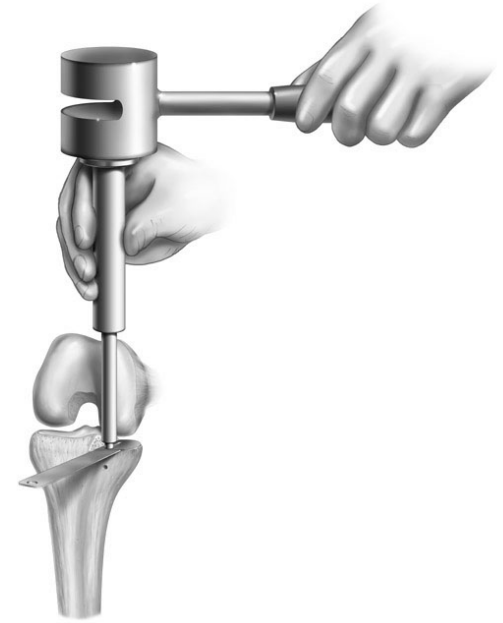

uni345m-review01.jpg



uni347m-review01.jpg



uni349m-review01.jpg



op001-review03.jpg



op002-review01.jpg



op003-review04.jpg

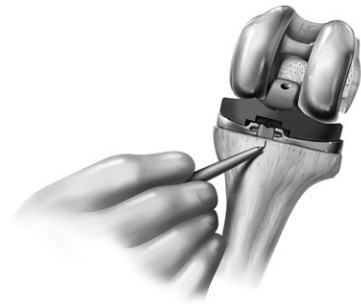

op004-review03.jpg



op005-review01.jpg



op006-review03.jpg

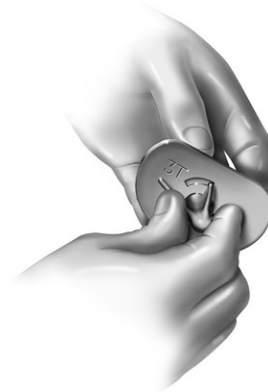

op007A-review01.jpg



op007-review01.jpg



op008-review03.jpg



op009-review01.jpg



op011-review01.jpg



op012-review01.jpg



op014A-review01.jpg



op014B-review01.jpg

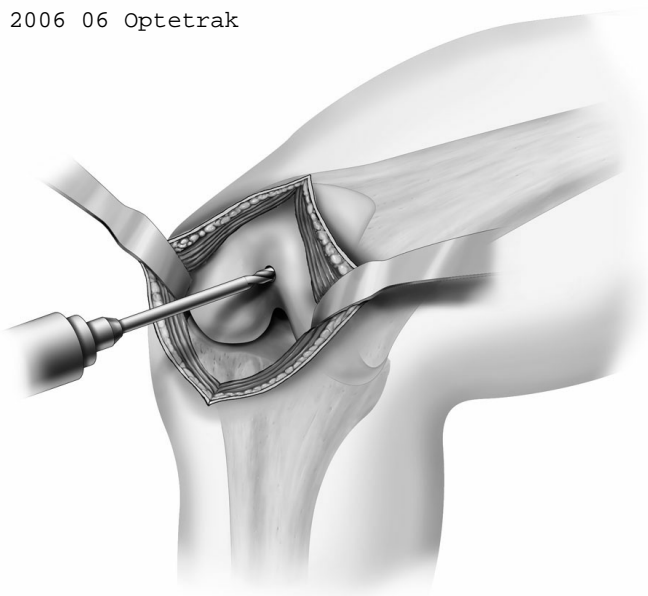

b_Fig_01-preview01.jpg

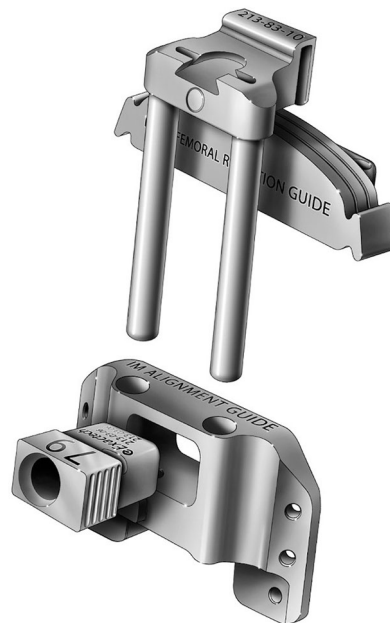

b_Fig_02-preview01.jpg

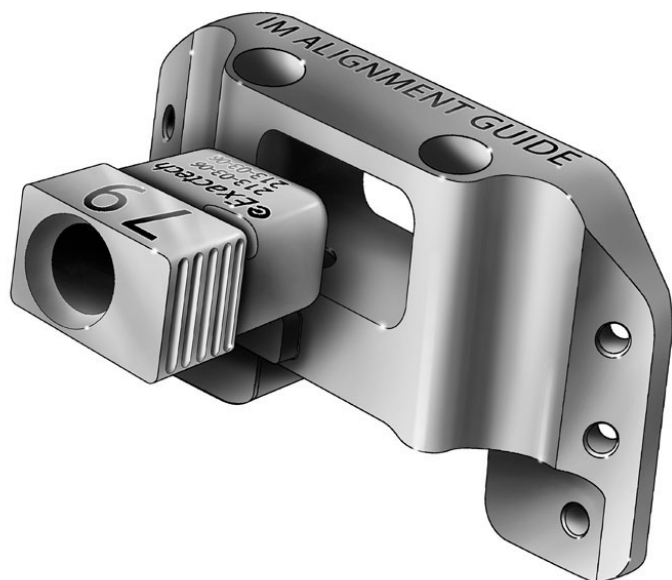

b_Fig_03-preview01.jpg

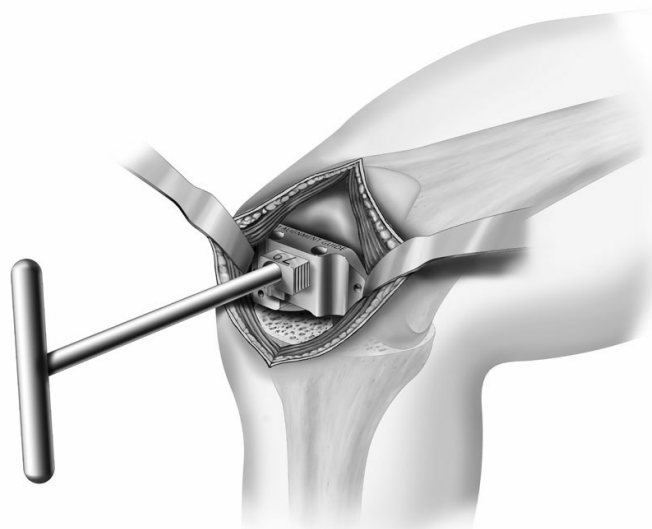

b_Fig_04-preview01.jpg

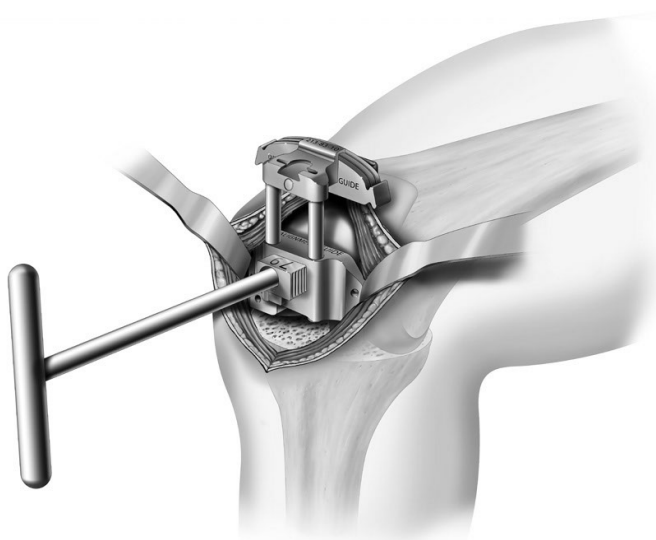

b_Fig_06-preview01.jpg

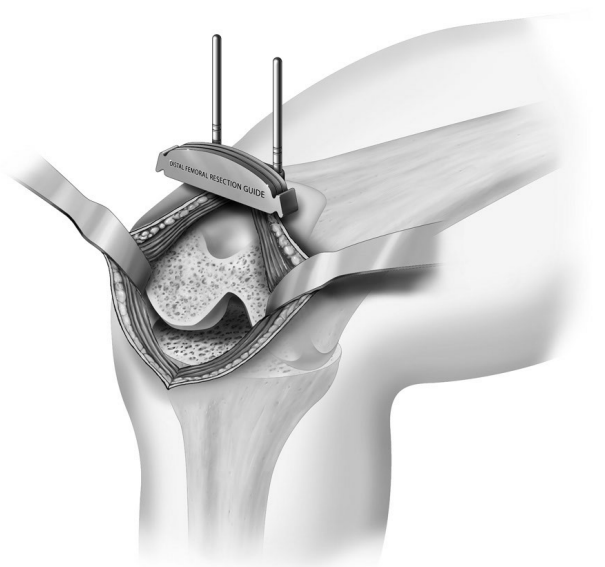

b_Fig_07-preview02.jpg



213-83--00-preview01.jpg



213-83-10-preview01.jpg



213-164-01-preview01.jpg

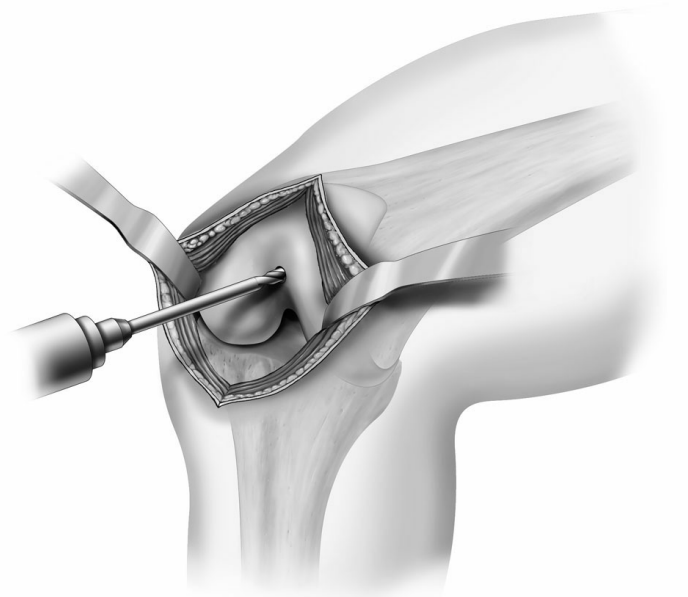

b_Fig_01-preview01.jpg

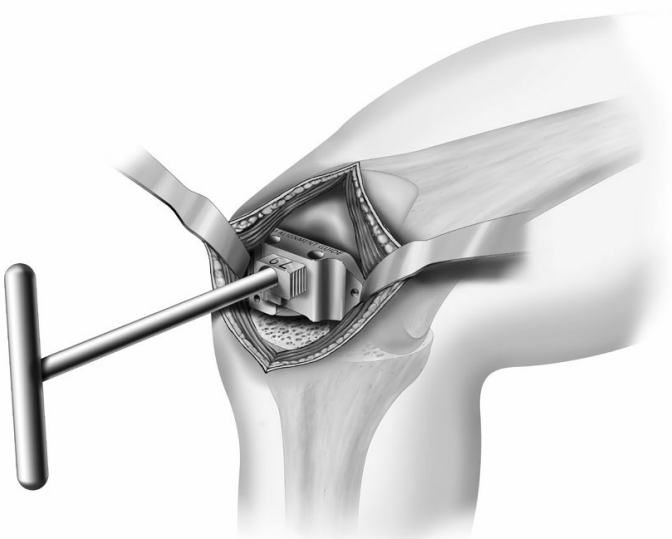

b_Fig_04-preview01.jpg

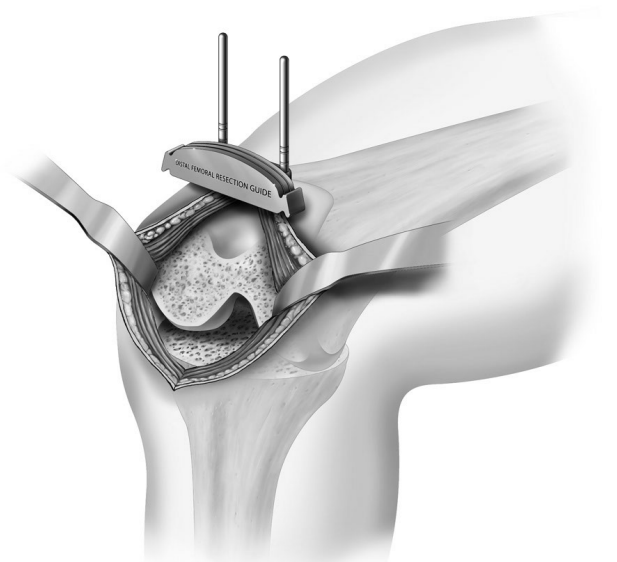

b_Fig_07-preview02.jpg



b_Fig_08-preview02.jpg

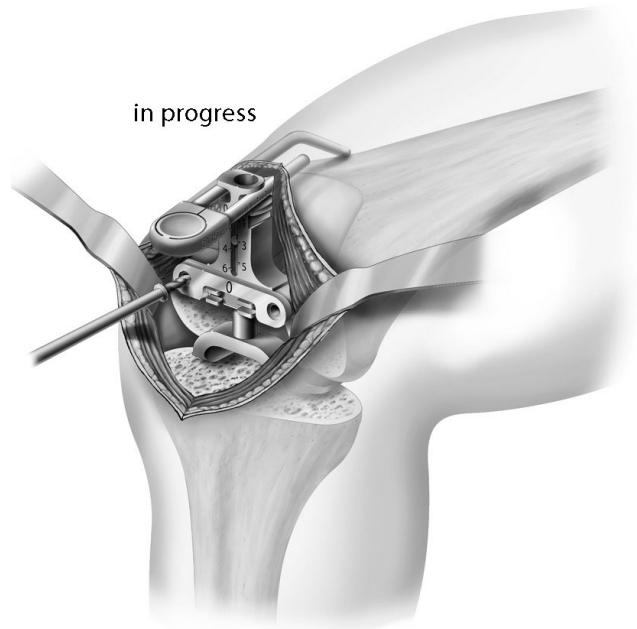

b_Fig_09-RFC-preview03.jpg

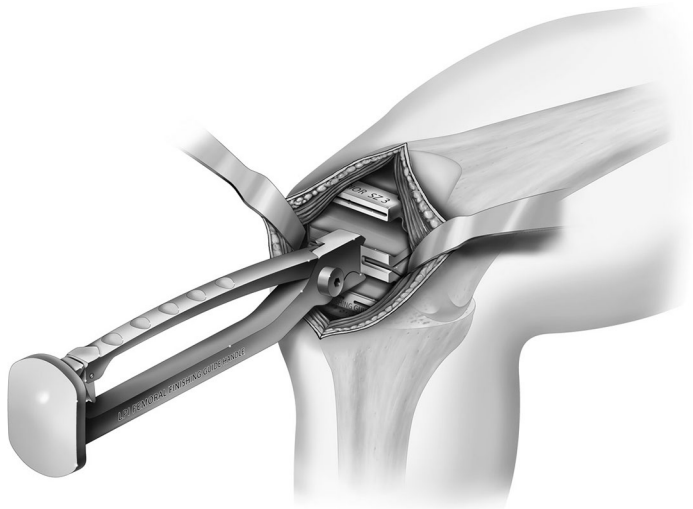

b_Fig_10-preview01.jpg

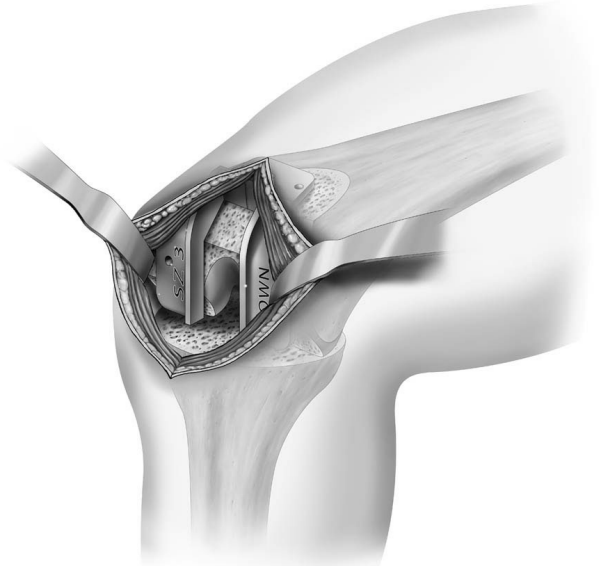

b_Fig_11-preview01.jpg



c_213-153-00_06-preview01.jpg



c01_213-73-07-preview01.jpg



c02_213-02-00-preview01.jpg



c03_213-03-02-preview01.jpg

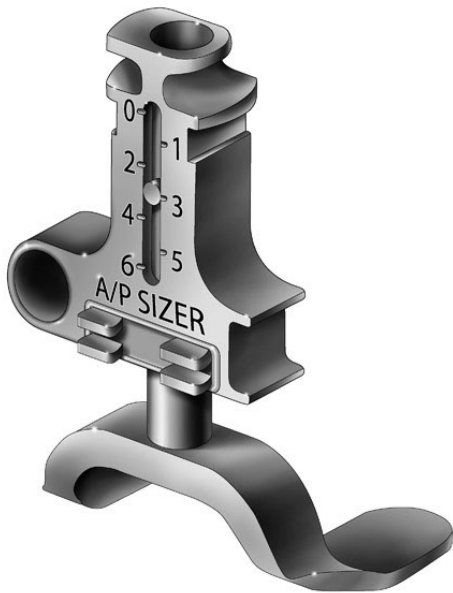

c06_213-37-00-preview01.jpg

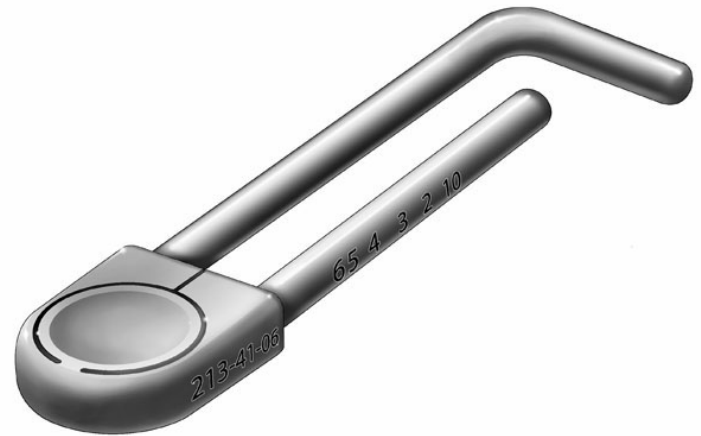

c07_213-41-06-preview02.jpg



c08_213-44-01-preview01.jpg

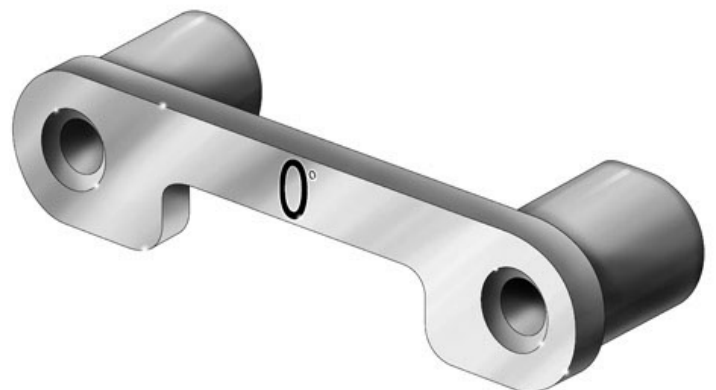

c09_213-48-03-preview01.jpg



c10_213-50-10-preview01.jpg



c11_213-52-10-preview01.jpg

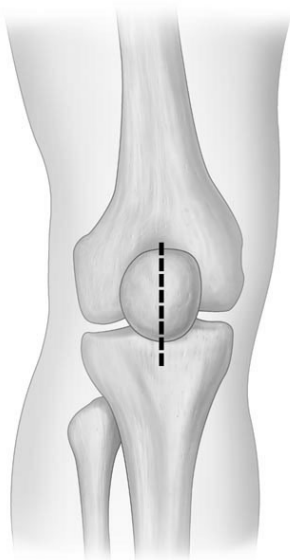

d01z-preview01.jpg

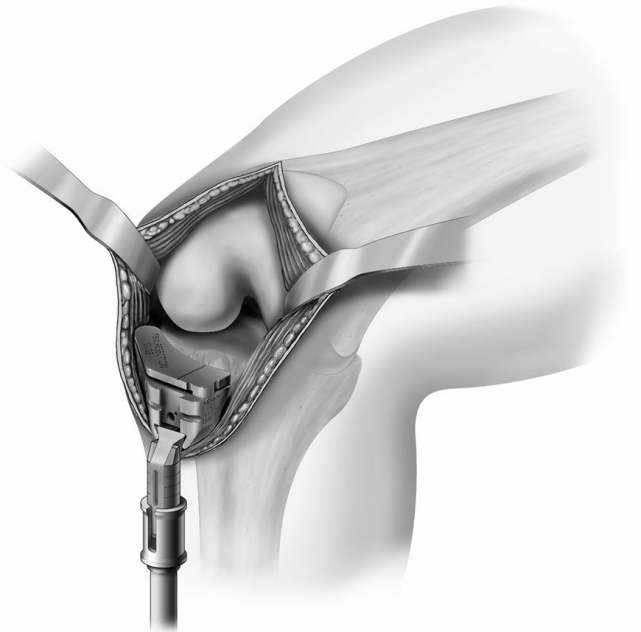

d02-preview01.jpg

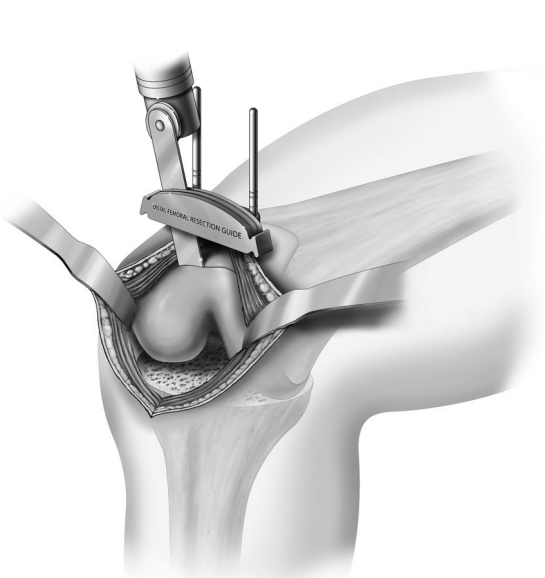

d04-preview01.jpg



d05-preview01.jpg



uni01-prev05.jpg



uni02-prev06.jpg

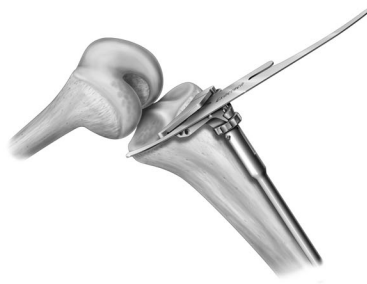

uni02A-prev03.jpg



uni02B-prev03.jpg



uni04-prev03.jpg

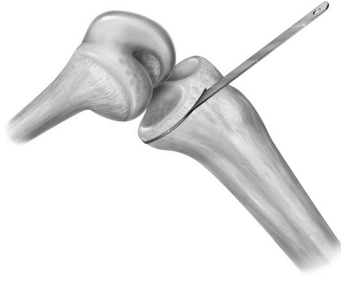

uni08-prev03.jpg

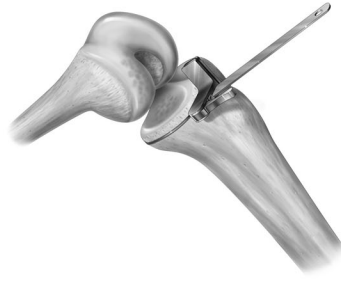

uni09-prev03.jpg

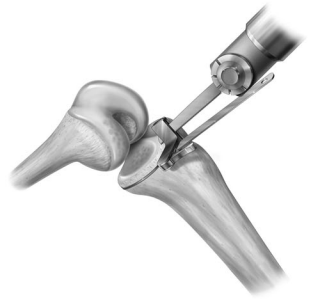

uni09A-prev06.jpg

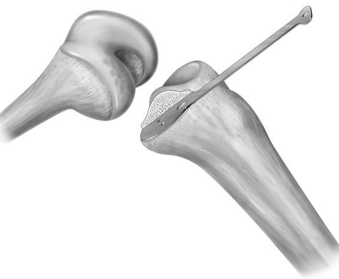

uni10-prev04.jpg



uni10A-prev03.jpg

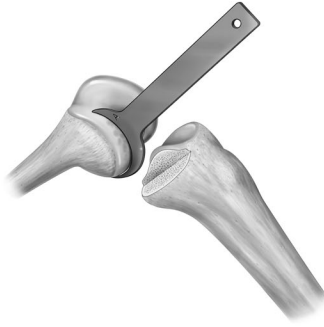

uni11-prev02.jpg



uni12-prev03.jpg



uni15-prev05.jpg

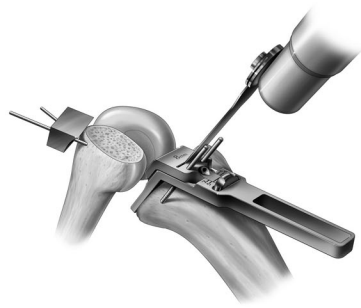

uni18-prev03.jpg



uni19A-prev01.jpg



uni19B-prev02.jpg



uni20-prev02.jpg



uni20A-prev01.jpg

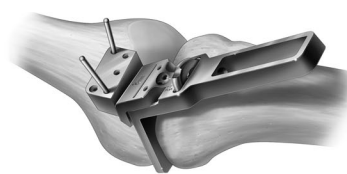

uni21-prev01.jpg

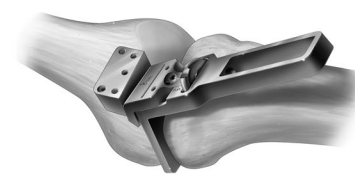

uni21A-prev01.jpg

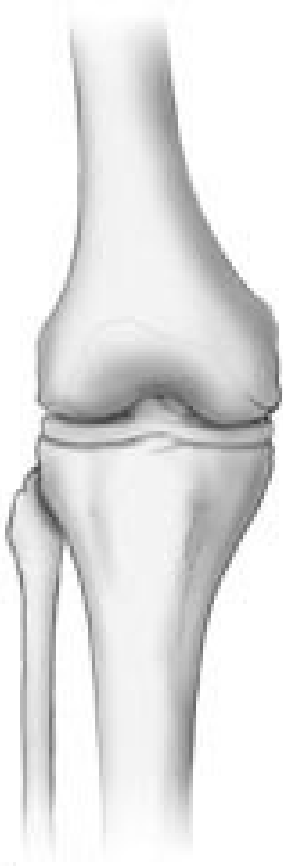

sketch

kneeArt01-prev01.jpg



kneeArt03-prev01.jpg



kneeArt04-prev01.jpg



kneeArt05-prev01.jpg

2008 01 Bertam Knee Replacement

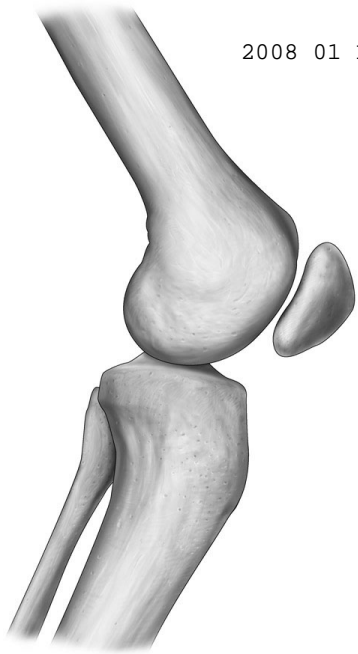

tkr01-prev01.jpg

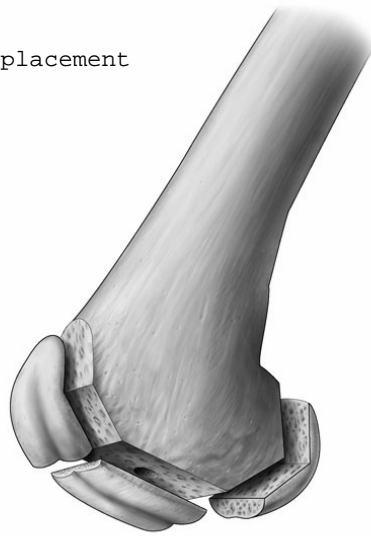

tkr02A-prev01.jpg

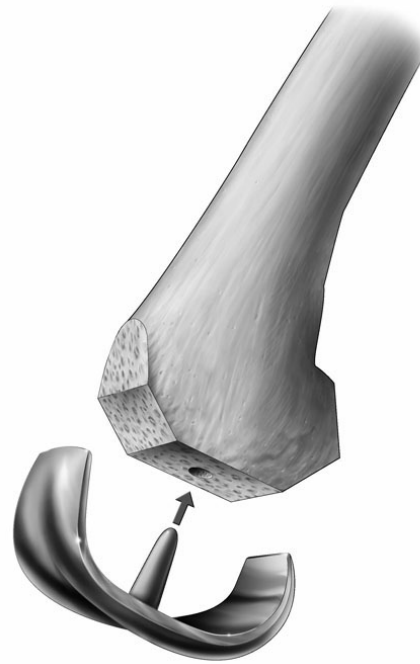

tkr02B-prev01.jpg



tkr03-prev01.jpg

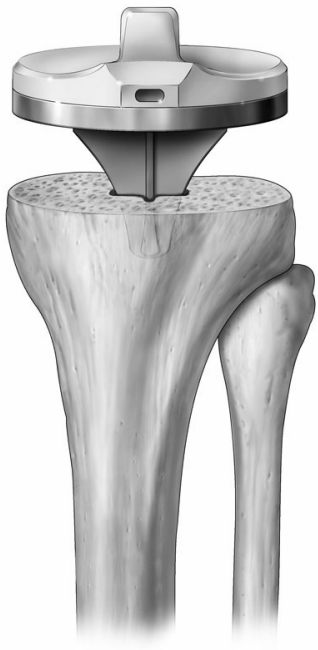

tkr03B-prev01.jpg

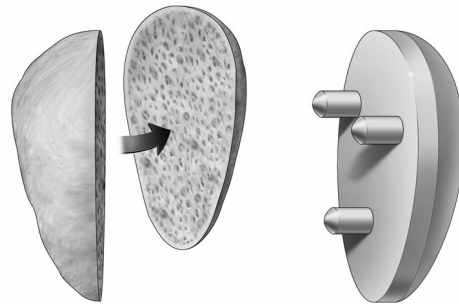

tkr04-prev03.jpg

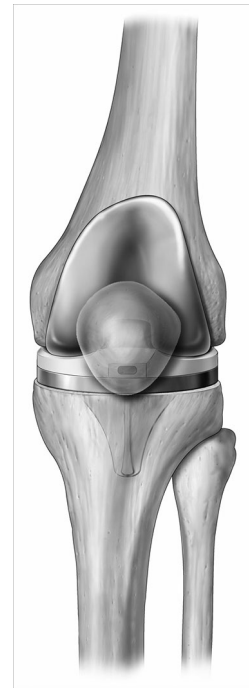

tkr05-prev02.jpg

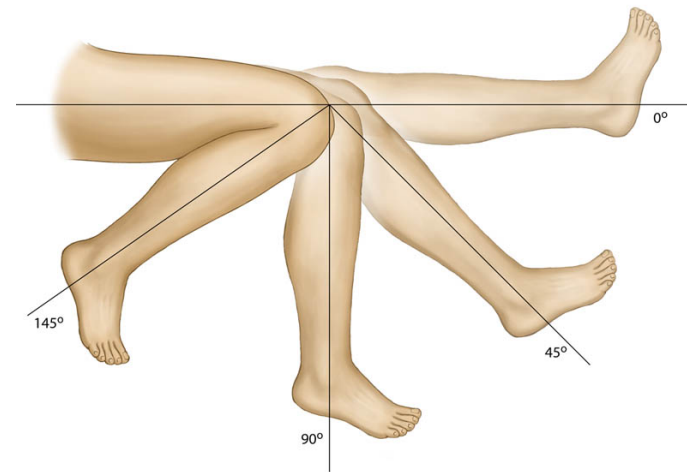

2006 11 Range of Motion



blocks-prev01.jpg

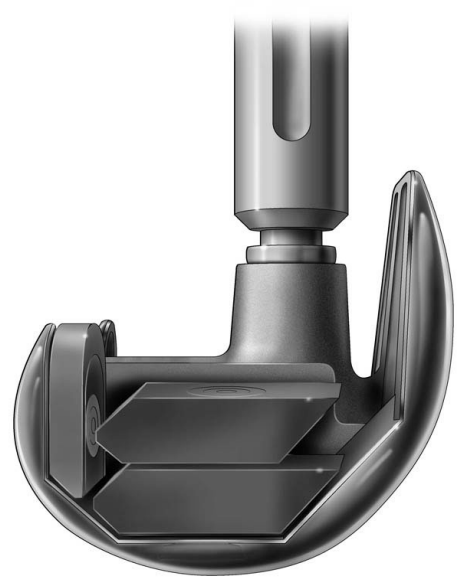

ccimage-prev01.jpg

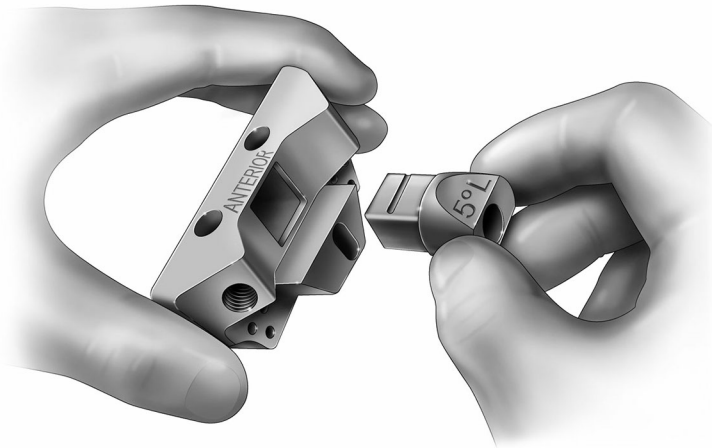

ot05-prev02.jpg



ot06-prev01.jpg

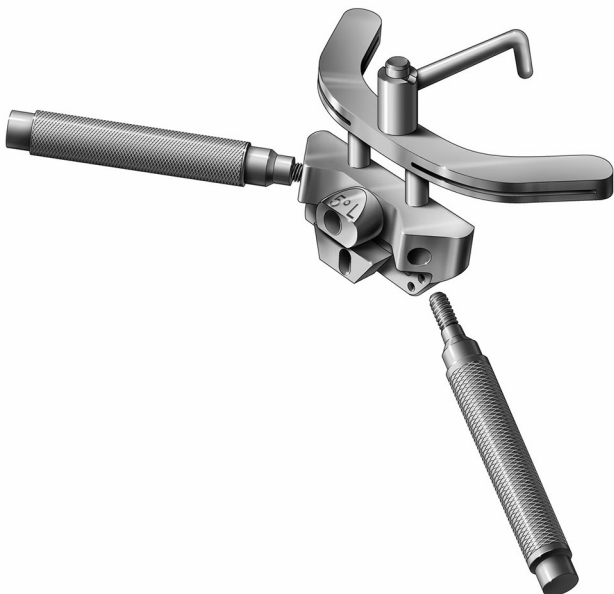

ot07-prev01.jpg



ot12-prev01.jpg



ot18-prev01.jpg



ot19-prev02.jpg



ot23-prev01.jpg

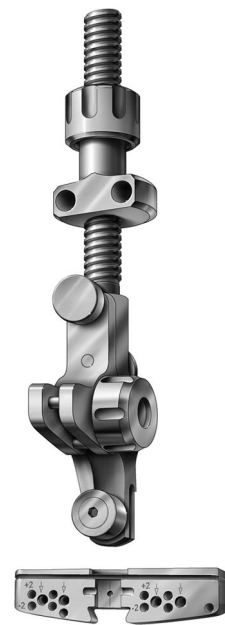

ot31-prev01.jpg

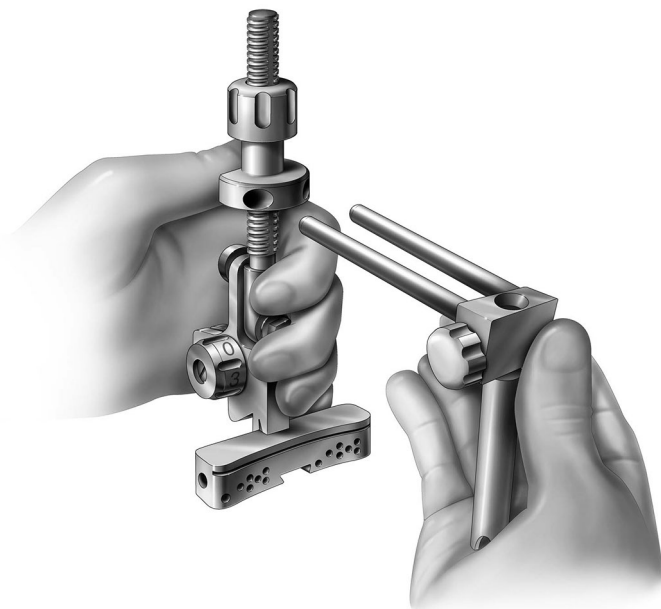

ot32-prev01.jpg

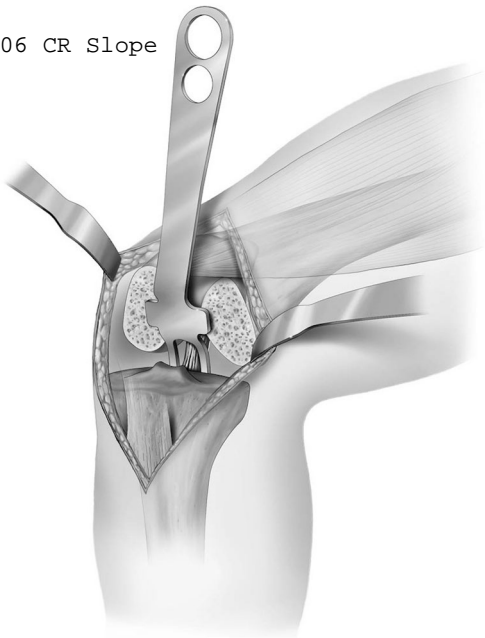

cr01-prevB01.jpg

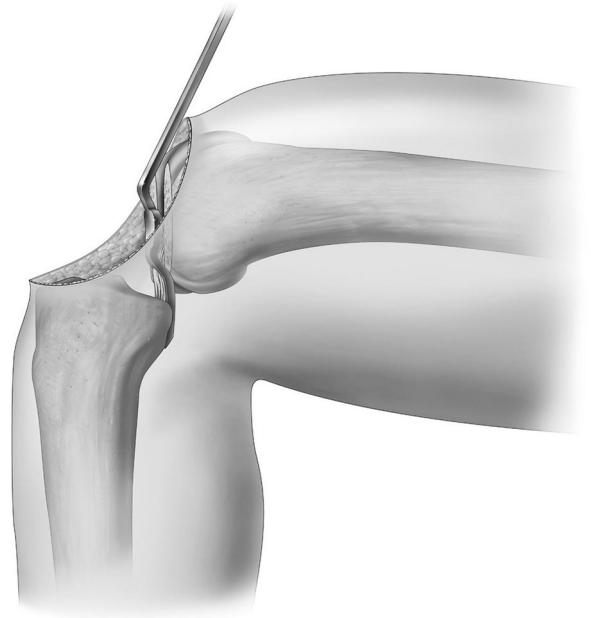

cr01B-prev02.jpg



cr02-prev03.jpg

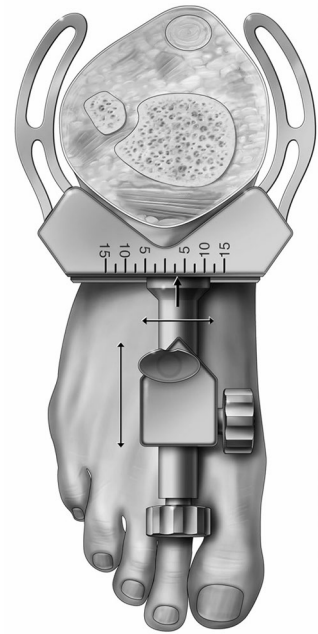

cr03-prev01.jpg



cr07-prev01.jpg

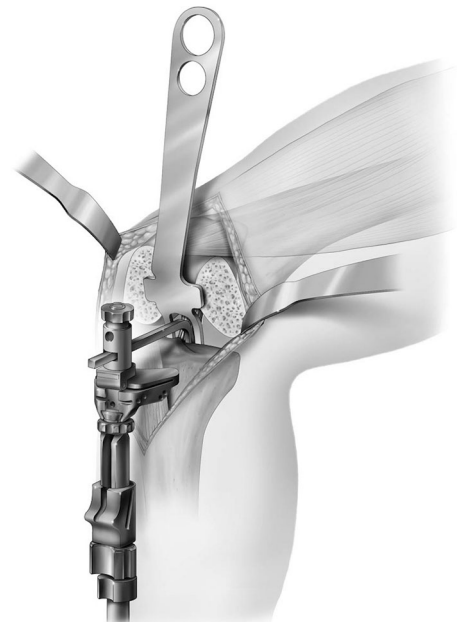

cr08A-prevB01.jpg

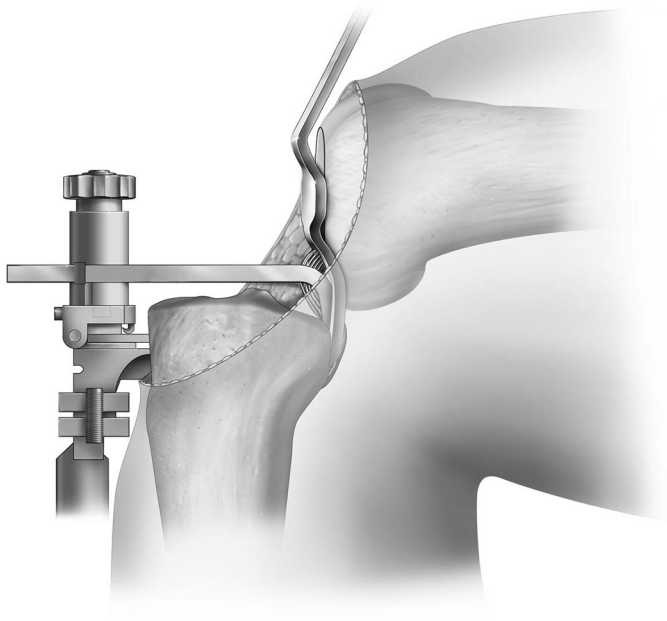

cr08B-prevB01.jpg

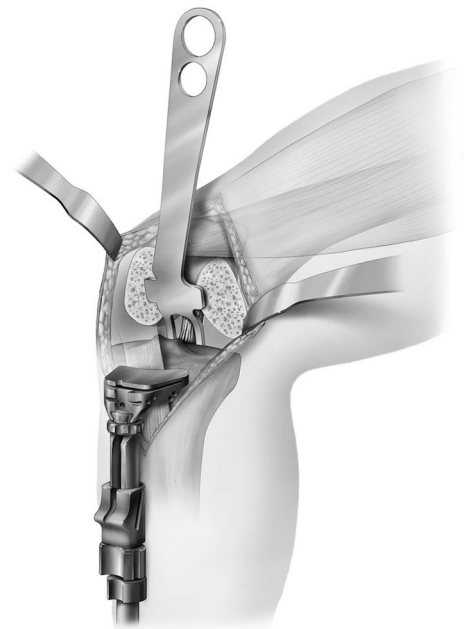

cr09-prevB01.jpg

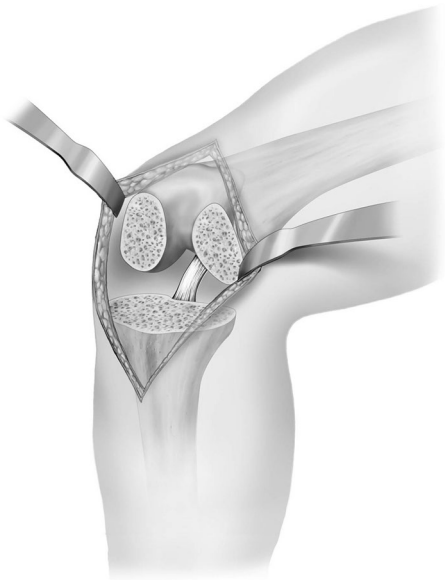

cr10-prev02.jpg

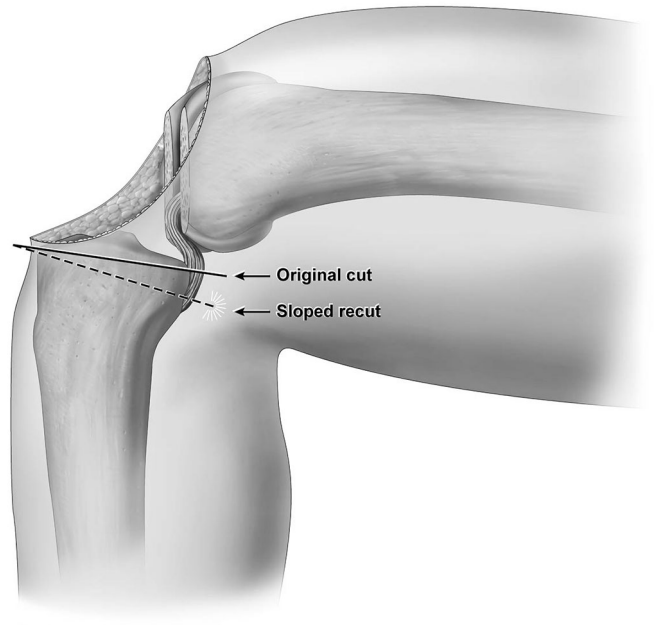

cr12-prev01.jpg

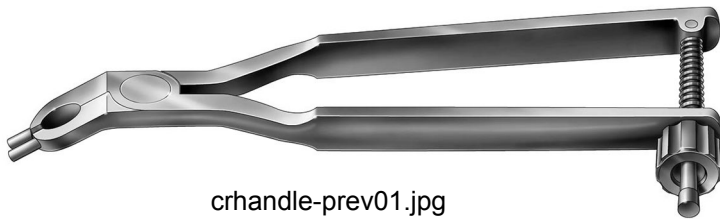

crhandle-prev01.jpg

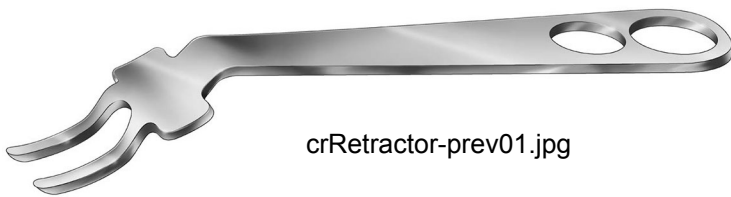

crRetractor-prev01.jpg

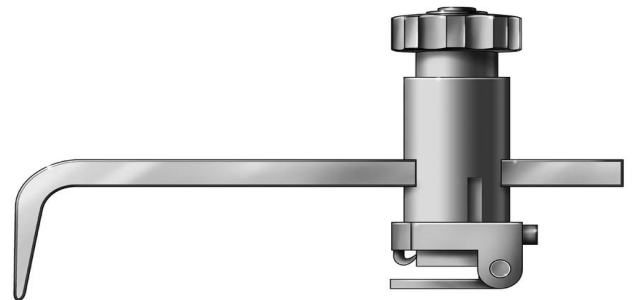

crStylus-prev01.jpg

**ThreeMoreSlope
2008 06**

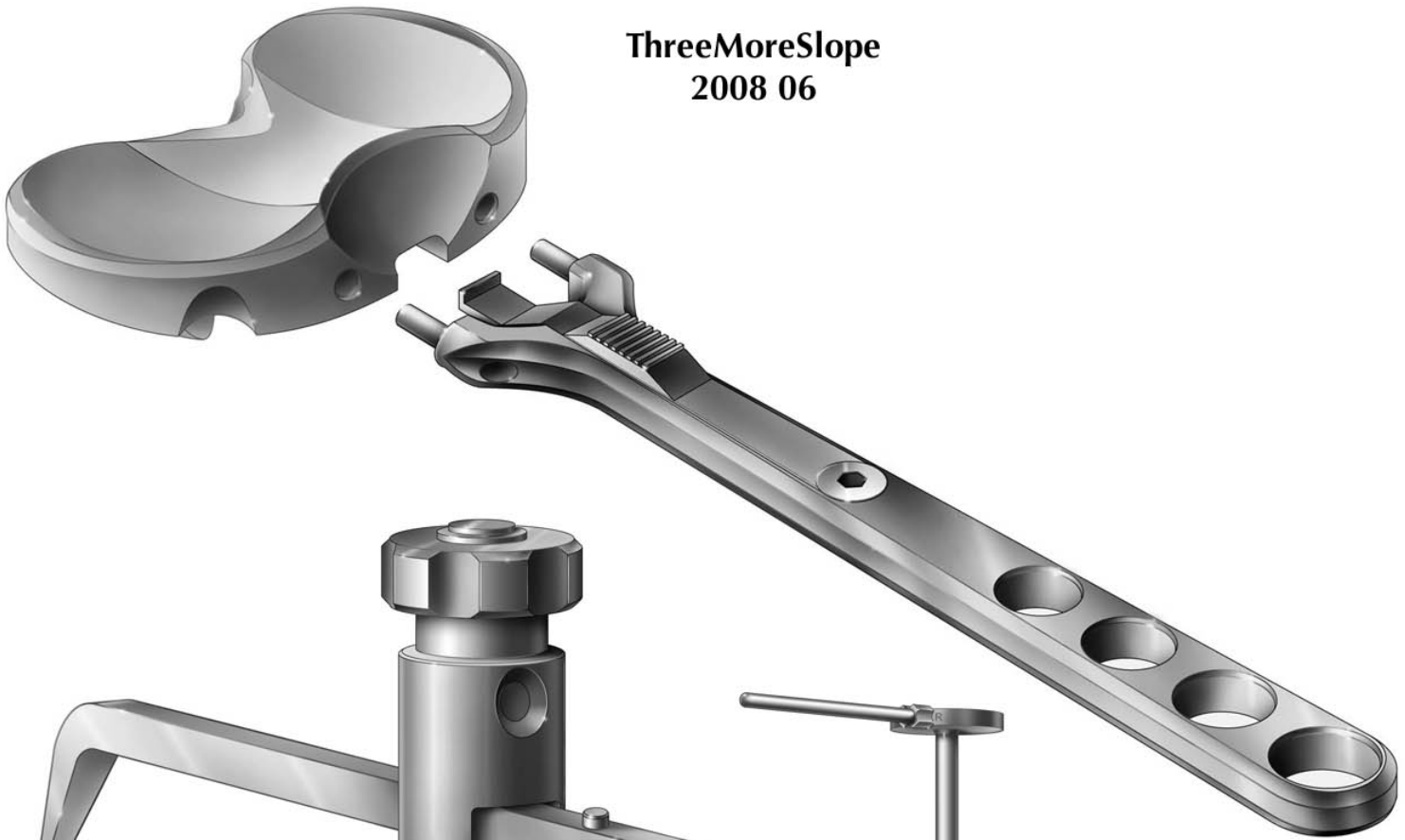

**Revise Pressfit
2008 06**

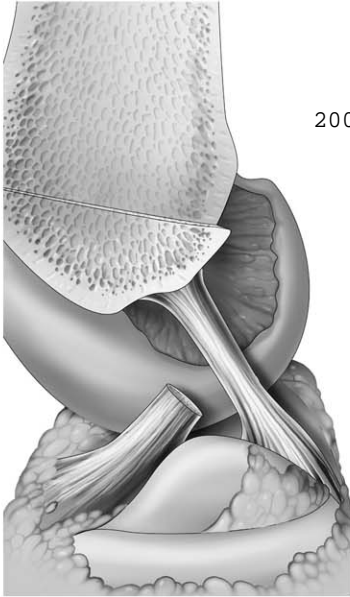

PCL01A-prev02.jpg

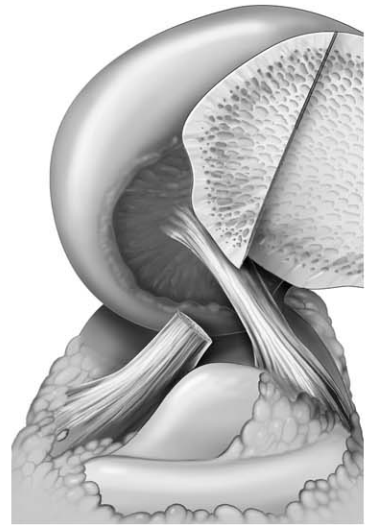

PCL01B-prev01.jpg

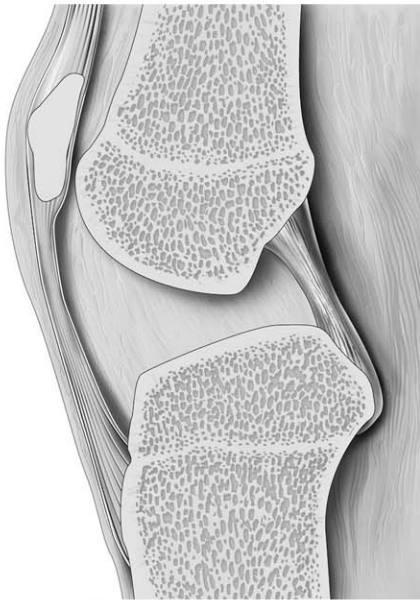

PCL02-prev02.jpg



PCL03-prev01.jpg

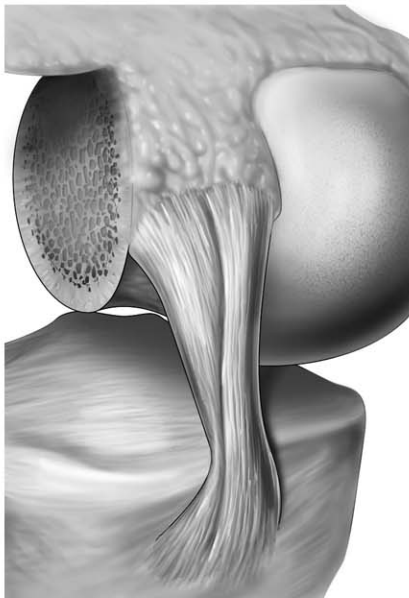

PCL04-prev01.jpg

200903exacLogic

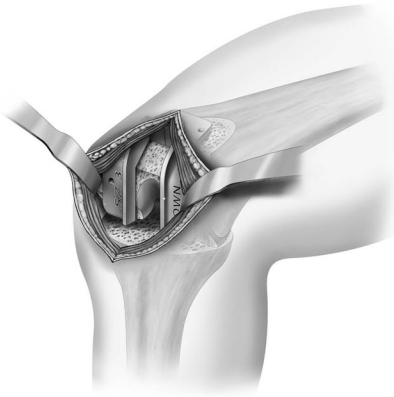

b_Fig_11-preview01.jpg

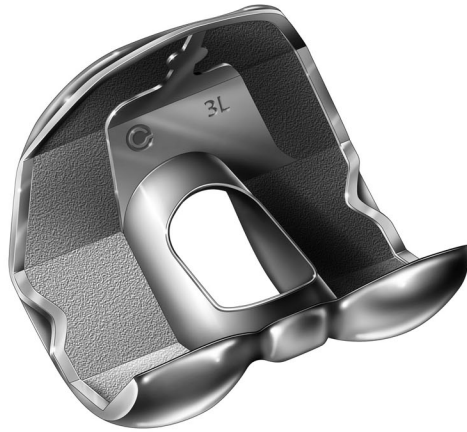

logic13a-prev01.jpg

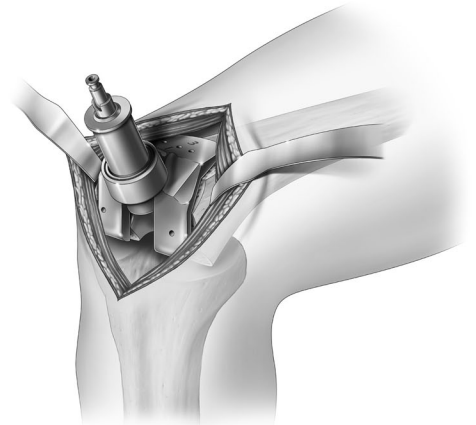

logic13c-prev01.jpg

2008 09 MRI

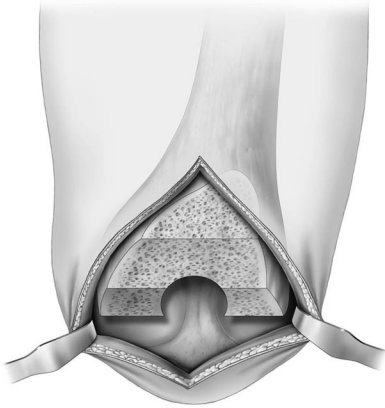

logic23c-prev01.jpg



kneeA-prev03.jpg

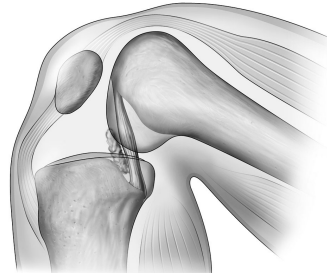

kneeB-prev02.jpg

2009 02

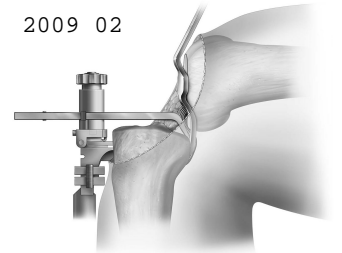

cr08B_rev-prev01.jpg

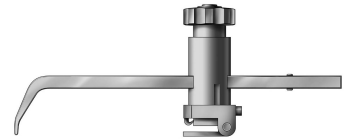

crStylus_rev-prev01.jpg

200905CRPS_GFlowers

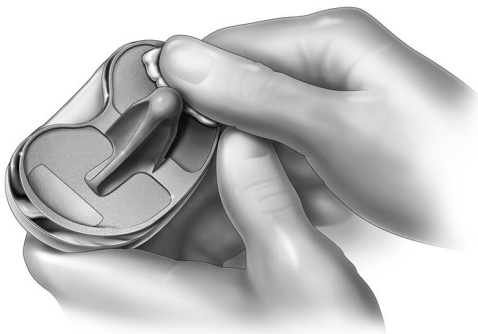

crps01-prev01.jpg

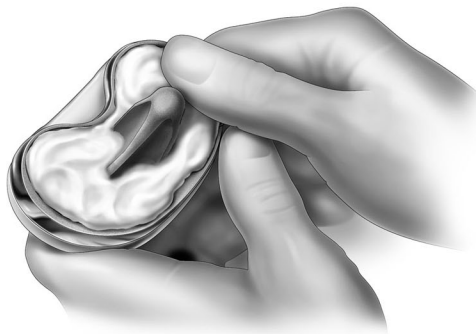

crps02-prev04.jpg

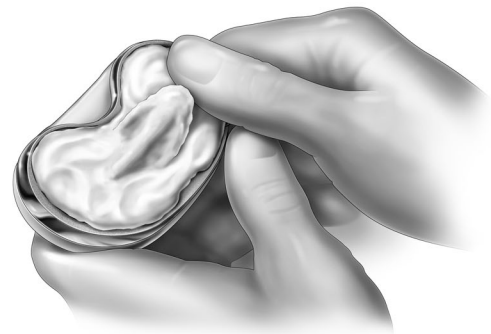

crps03-prev01.jpg



crps01-prev01.jpg

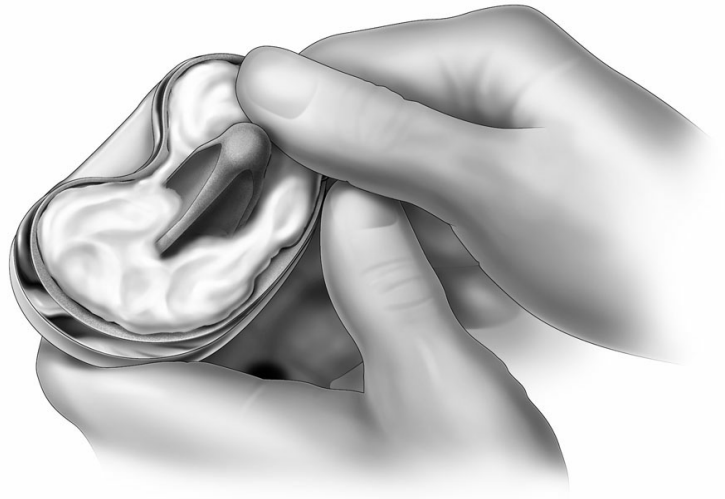

crps02-prev04.jpg

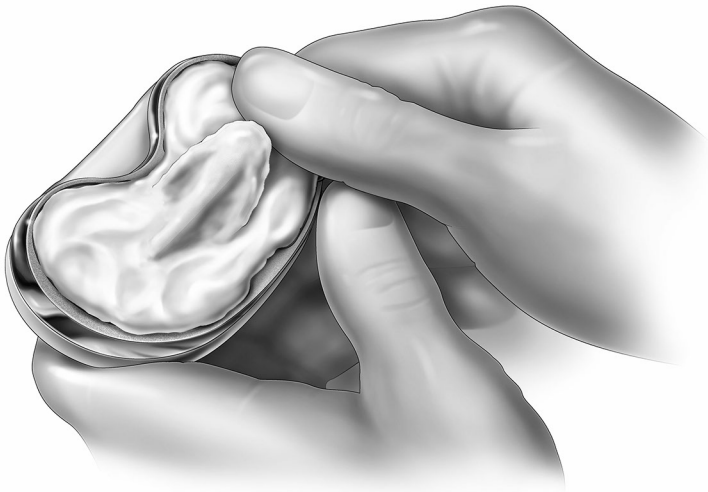

crps03-prev01.jpg

2009 06 impact G Flowers

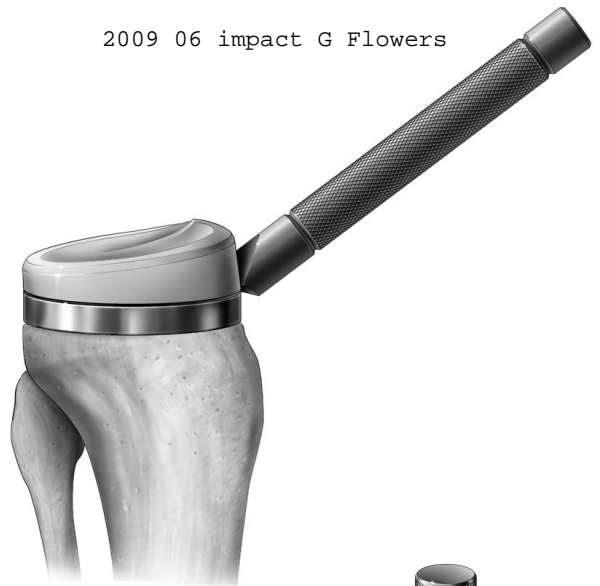

2009 10 Optetrak Revisions

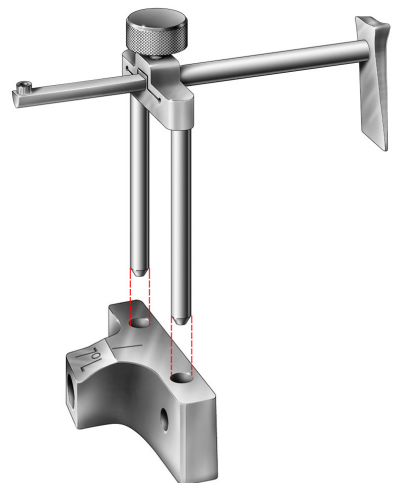
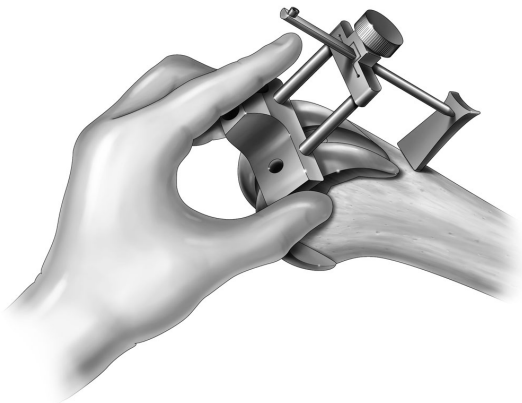

2009 06

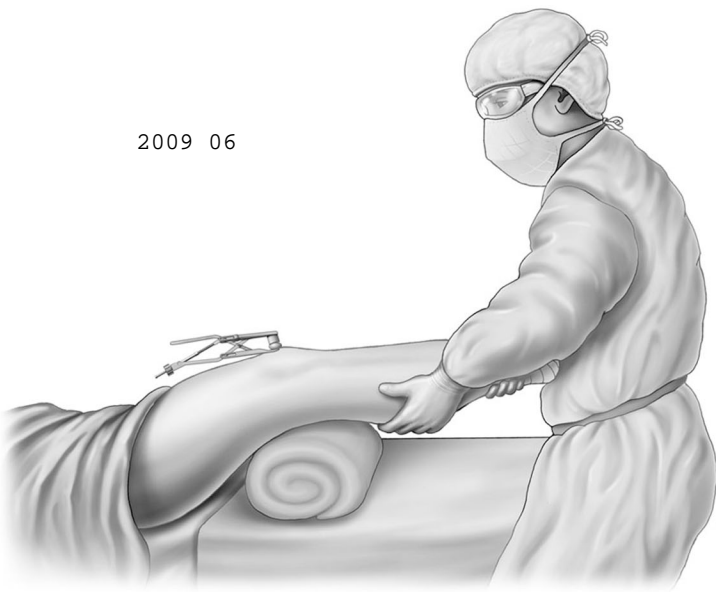

axialload-prev01.jpg



kneeArt03-prev01.jpg



kneeArt05-prev01.jpg

2010 04

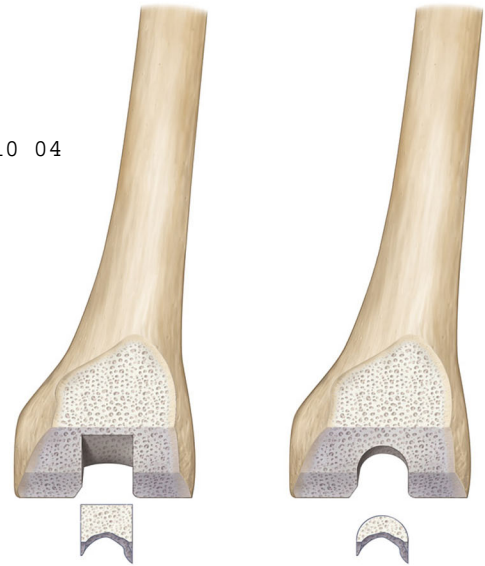

notchvolume-prev03.jpg

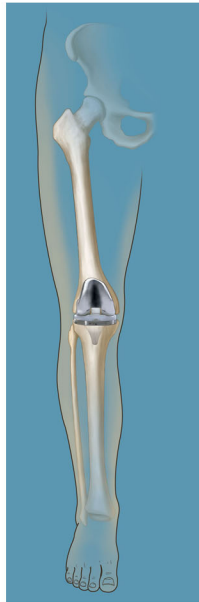

PBLeg-prev01.jpg

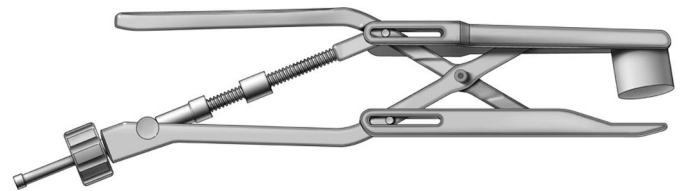

petclamp-prev01.jpg



lp01.psd

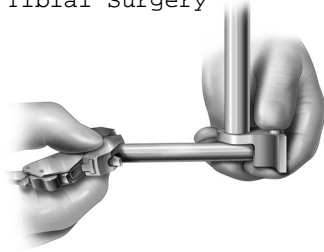

lp03.psd

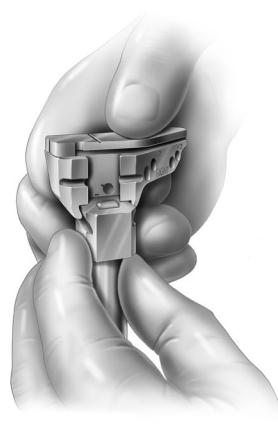

lp04.psd



lp05.psd



lp06A.psd

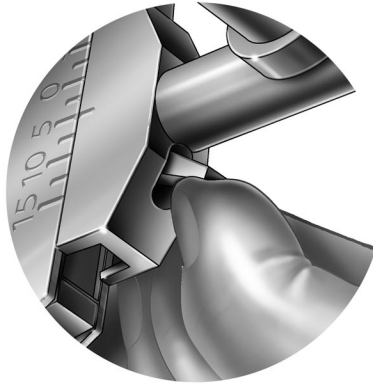

lp06B.psd

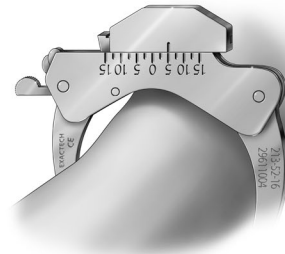

lp07.psd

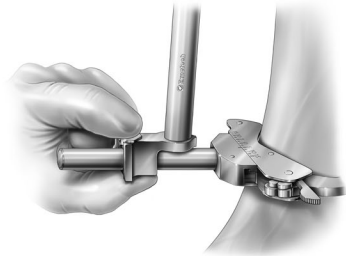

lp11A.psd



lp11B.psd

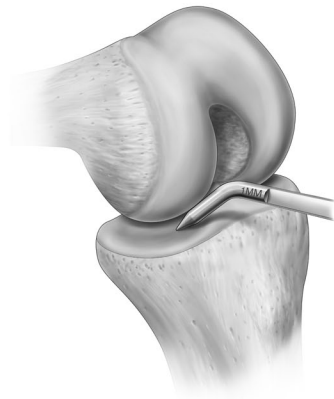

lp12A.psd

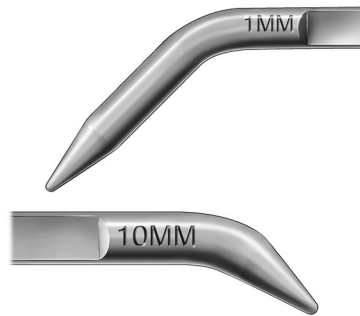

lp12B.psd



lp13.psd

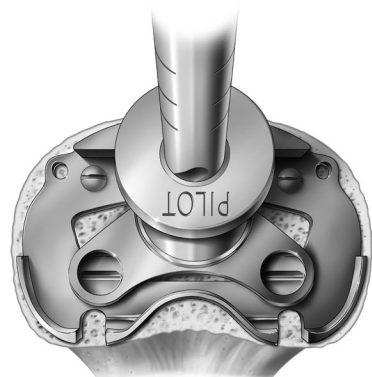

lp14.psd

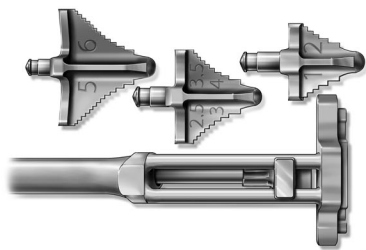

lp15A.psd



lp15B.psd

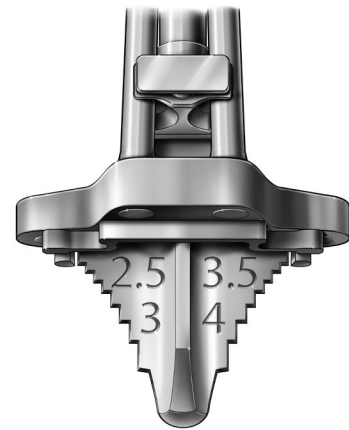

lp15C.psd

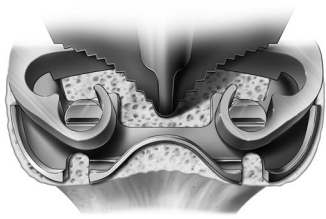

lp16A.psd



lp16B.psd

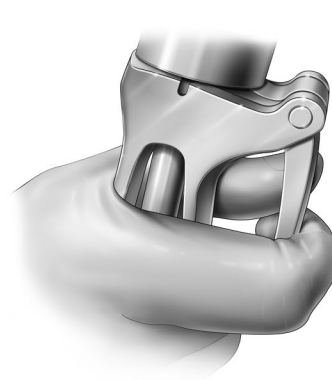

lp17.psd



lp18.psd



lp19handle.psd



lp19plates.psd



lp20.psd

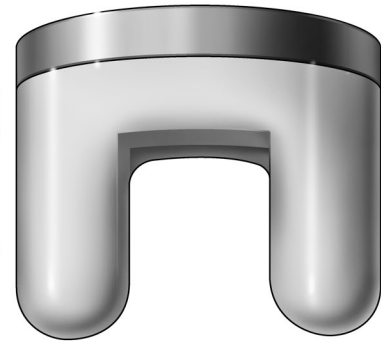

lp21.psd



lp213-52-11.psd



lp213-52-15_16.psd



lp213-53-30.psd



lp213-53-31.psd



lp213-65-00.psd



lp213-65-01_2_3.psd



lp213-70-10.psd

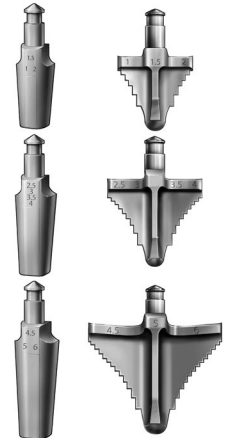

lp213-74-01to6.psd



lp213-77-01.psd



lp22A.psd



lp22B.psd



lp23A.psd

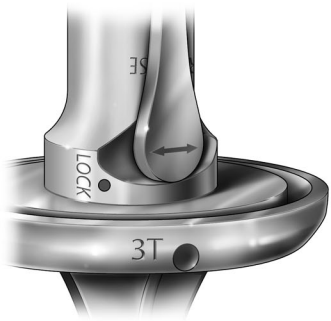

lp23B.psd



lp24.psd



lp25.psd



lp26.psd

2010 03 -05
LPI Tibial
Surgery

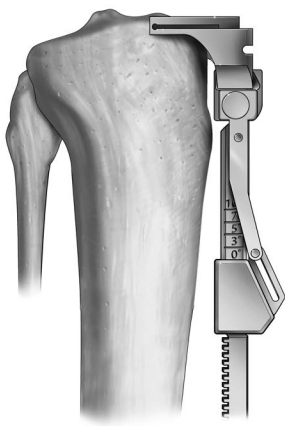

01_cr07rev01.psd

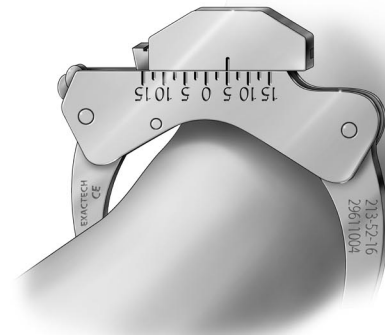

02_lp07rev01.psd

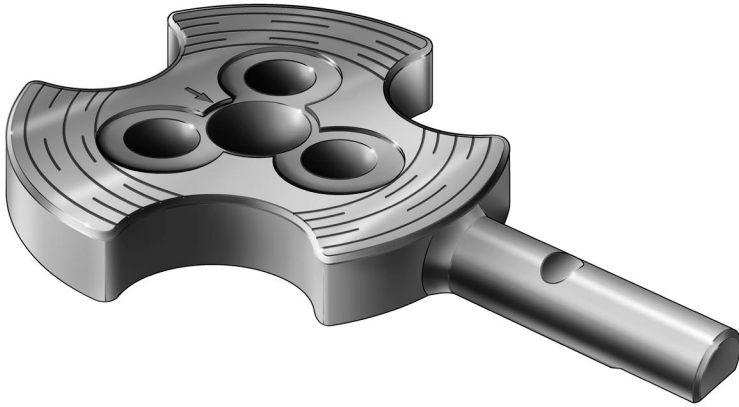

03_lp213-160-08-1.psd

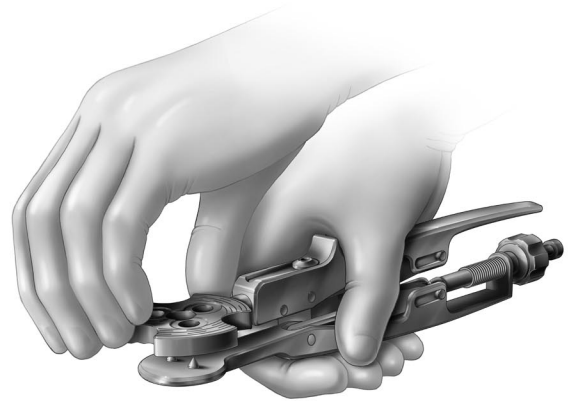

04_lp213-160-00-4.psd



05_lp213-160-00-3-patella.psd



06_lp213-160-00-4-patella.psd

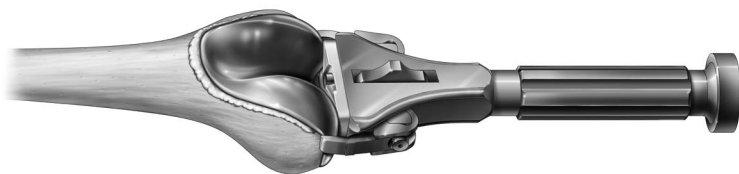

07_LockFemImp.psd



08_FemImpactAssembly.psd

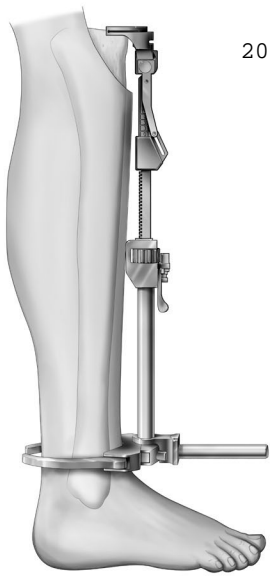

lpi001.psd

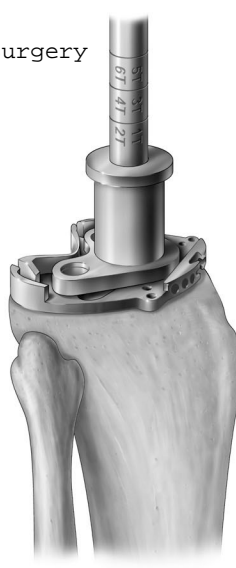

lpi002.psd



lpi003.psd



lpi004.psd



lpi005.psd



lpi006.psd



lpi007.psd



lpi008.psd



lpi009.psd

2010 08 knee

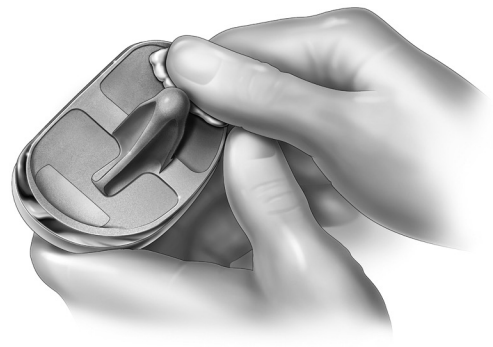
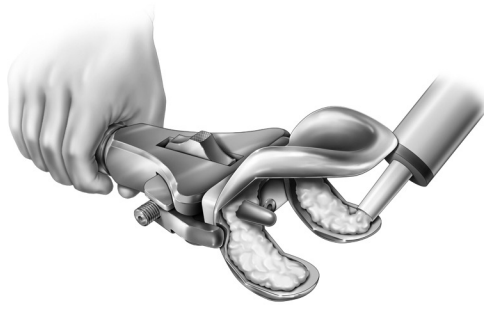
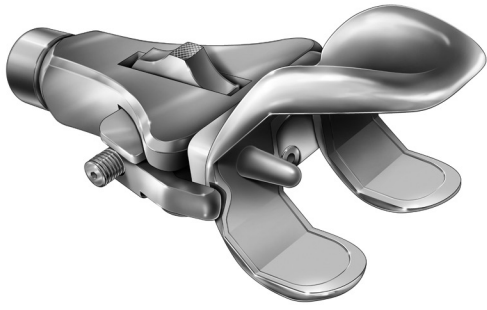

201006LocFemImp.psd

201009LocFemImp.psd

crps01new.psd

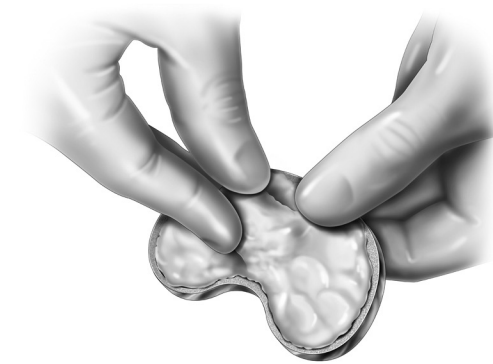

crps03.psd

crps03new.psd

crps04.psd

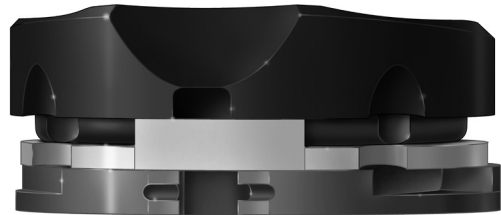
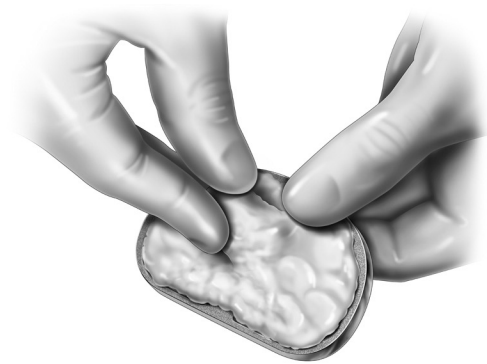

crps04new.psd

knee001.psd

knee002.psd

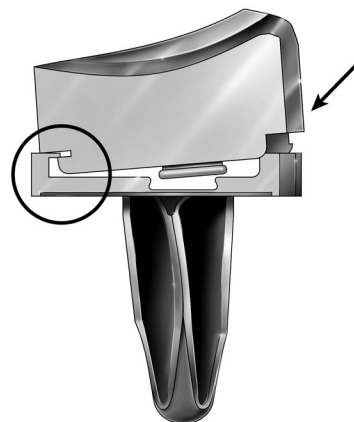

knee003.psd

knee004.psd

knee006a.psd

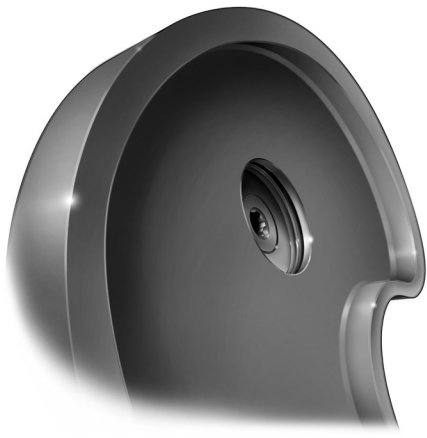

knee006b.psd



knee007.psd



knee008.psd



knee011.psd



knee012.psd

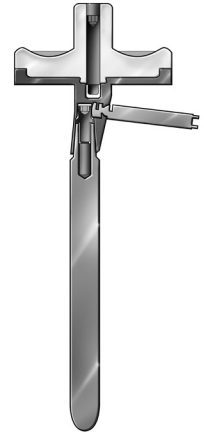

knee013.psd



knee014.psd



knee015.psd



knee016.psd

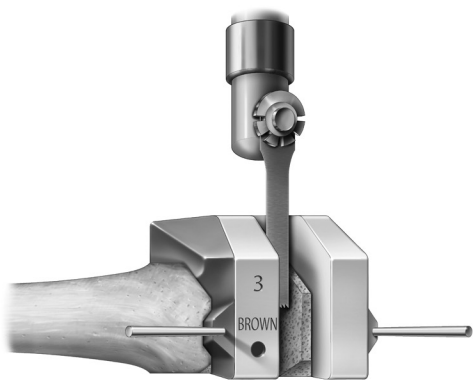

knee017.psd



knee018.psd



knee019.psd

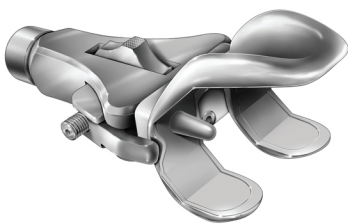

201006LocFemImp.psd



crps03.psd



crps04.psd



knee001.psd

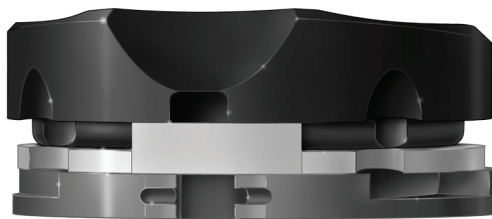

knee002.psd



knee003.psd

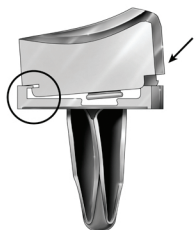

knee004.psd

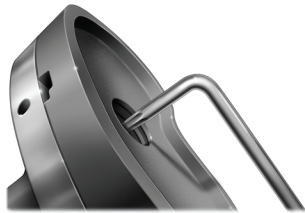

knee006a.psd

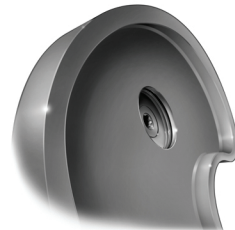

knee006b.psd



knee007.psd



knee008.psd

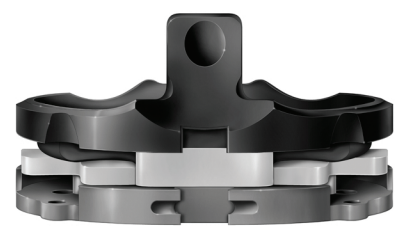

knee011.psd



knee012.psd



knee013.psd



knee014.psd



knee015.psd

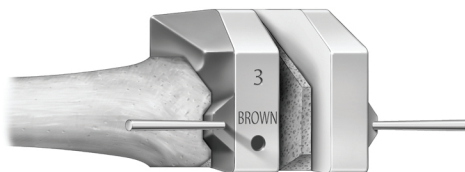

knee016.psd

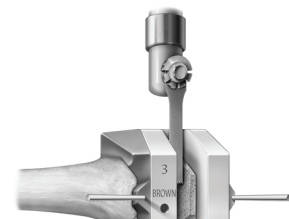

knee017.psd



knee018.psd



knee019.psd

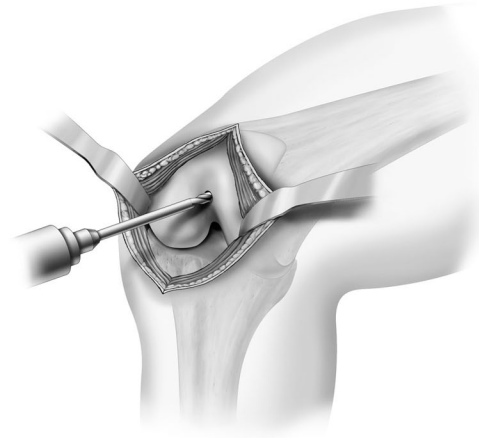

b_Fig_01-preview01.jpg

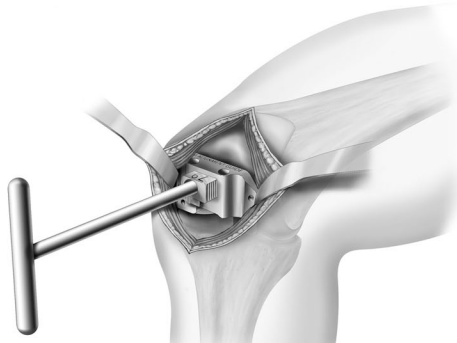

optefig10-prev01.jpg

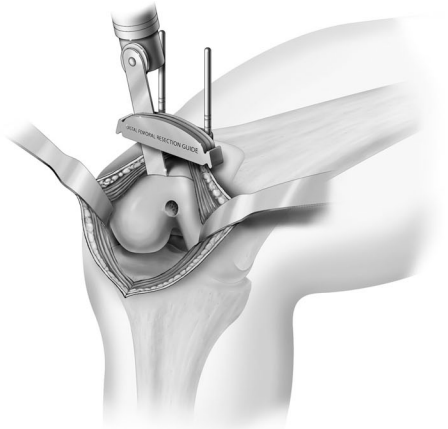

optefig12a-prev02.jpg

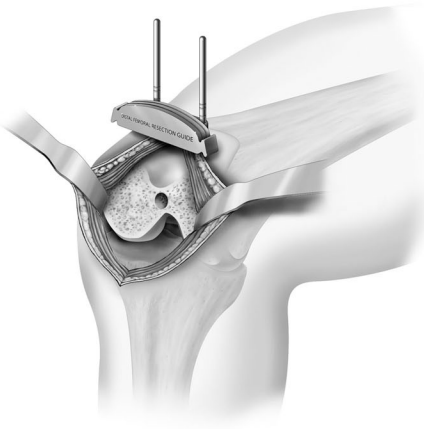

optefig12b-prev02.jpg



optefig13-prev01.jpg

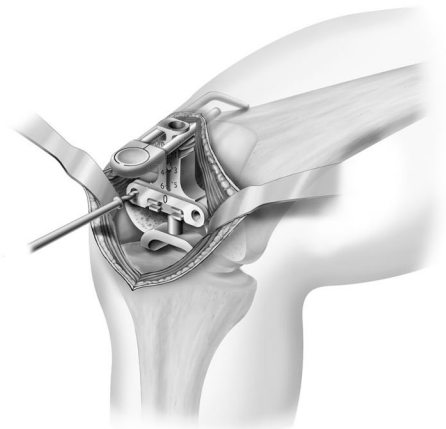

optefig14-prev01.jpg

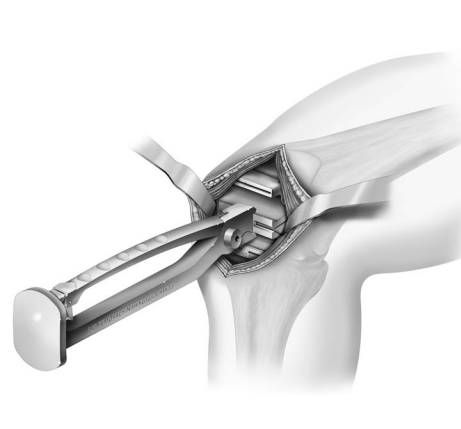

optefig15-prev02.jpg

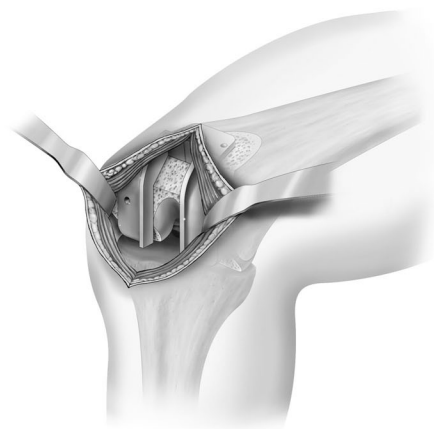

optefig16-prev02.jpg



optefig17-prev01.jpg

2010 09
Assessment

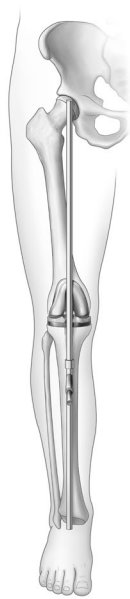

assess01.psd



assess02.psd



assess03.psd

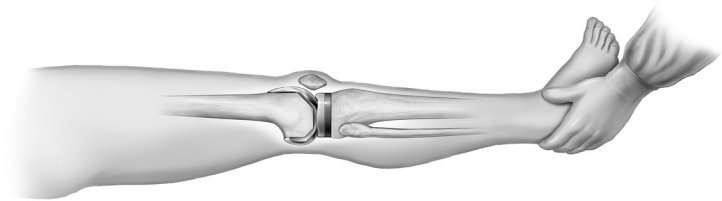

assess04.psd



assess05



Assess06.psd

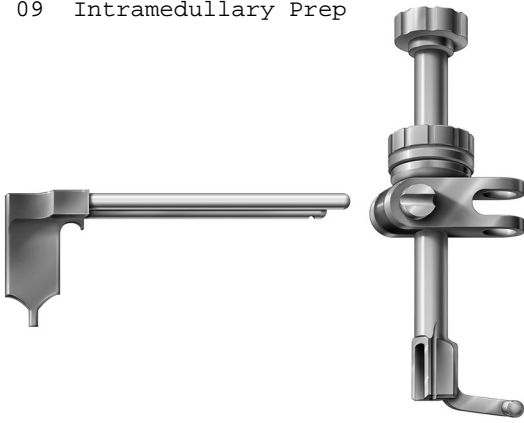

intramed001.psd

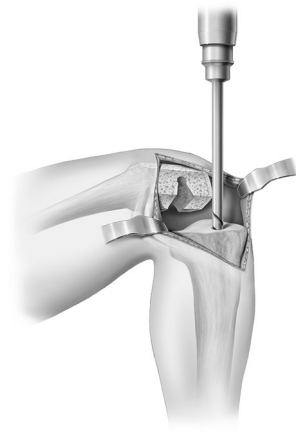

intramed002.psd

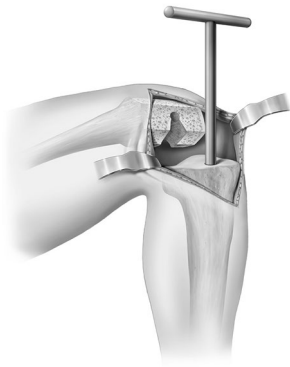

intramed003.psd

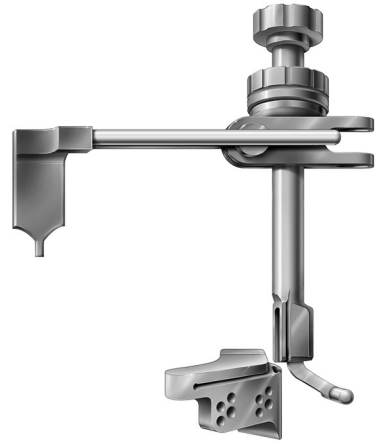

intramed004.psd



intramed005.psd



intramed006.psd

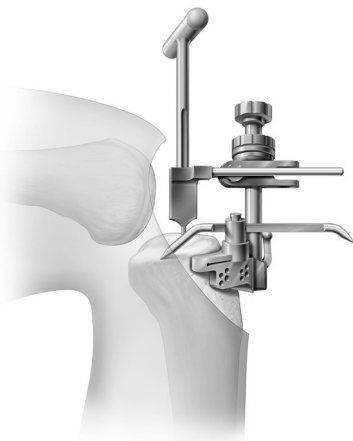

intramed007A.psd

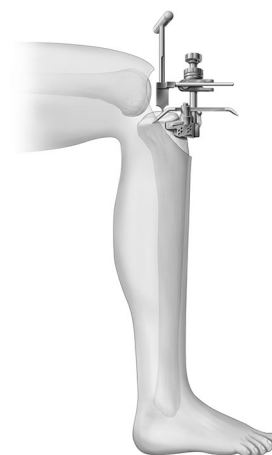

intramed007B.psd

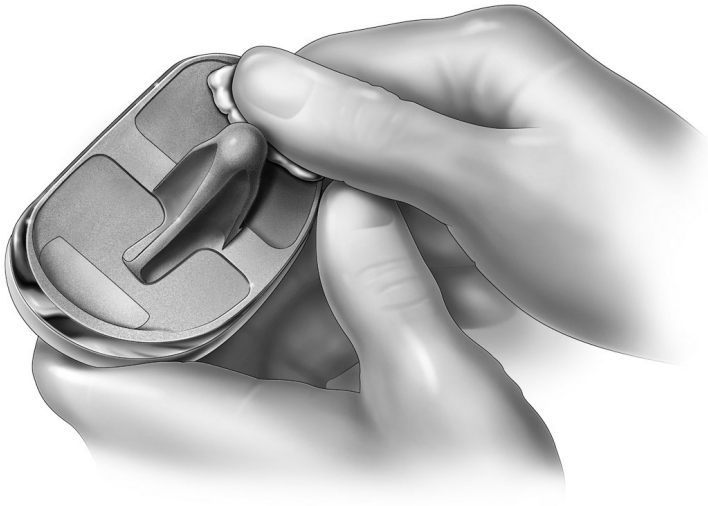

crps01new-prev01.jpg



crps03new-prev01.jpg

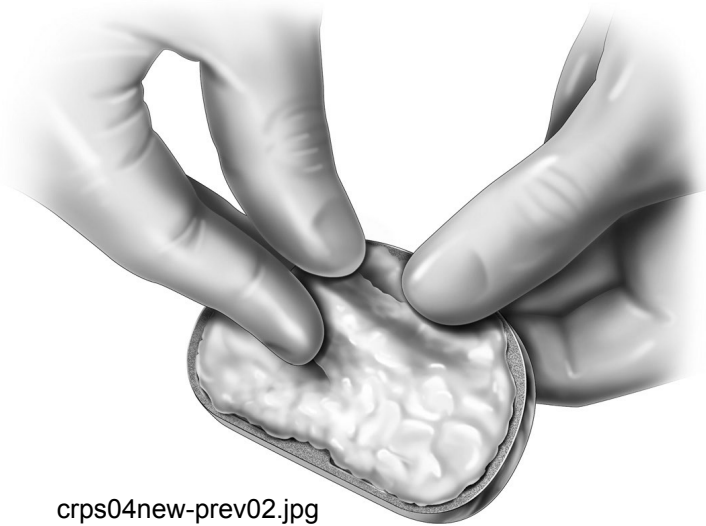

crps04new-prev02.jpg

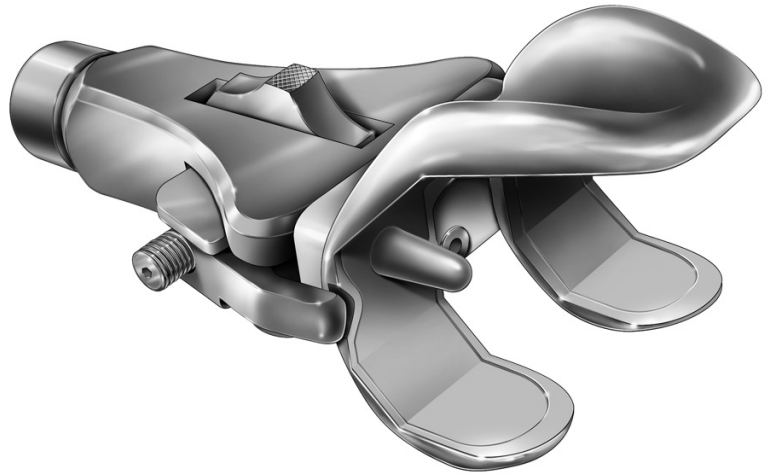

2010 09 Locking Femoral Implant

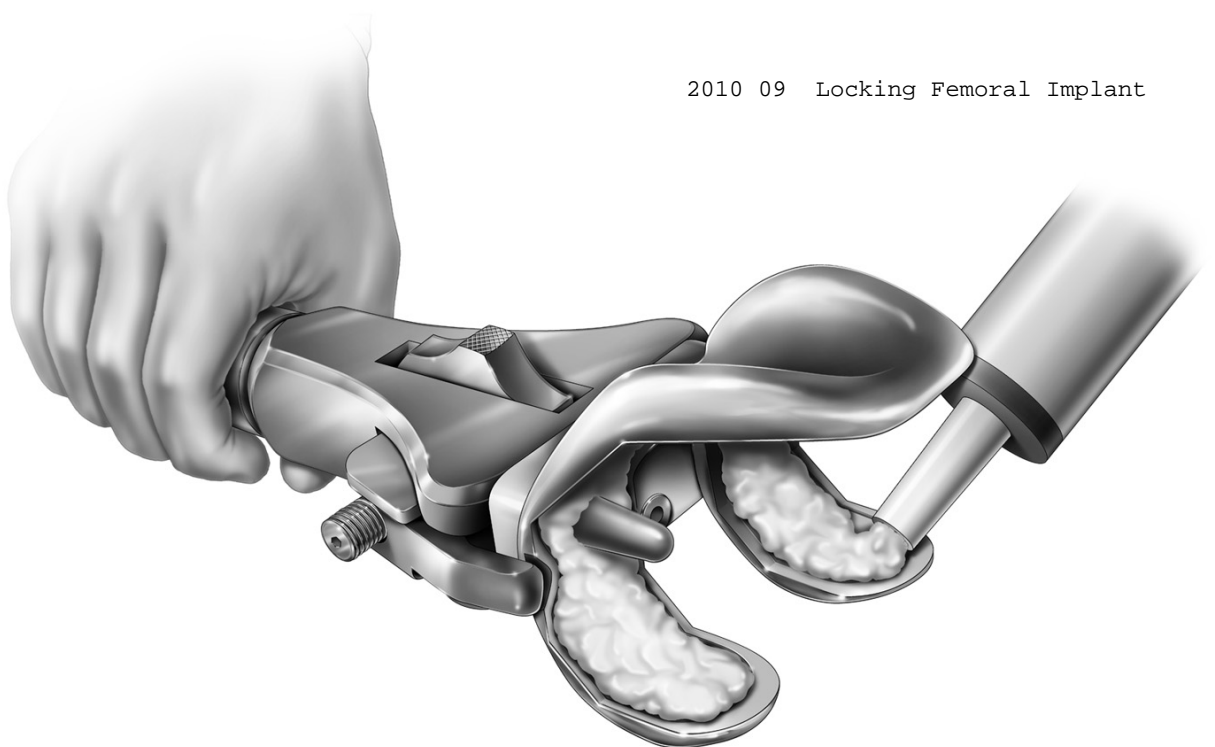

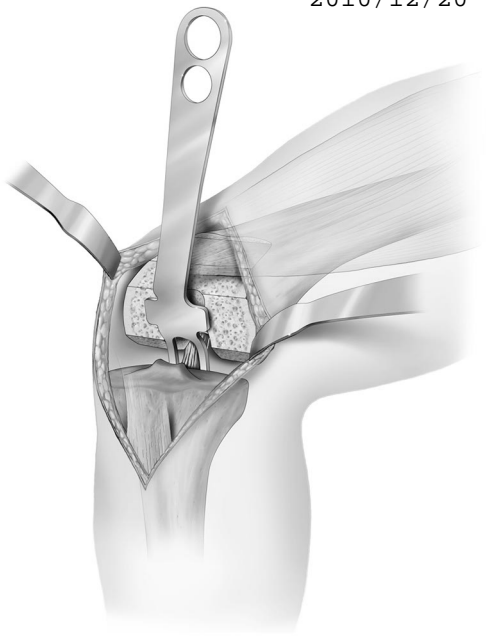

cr01rev01.psd

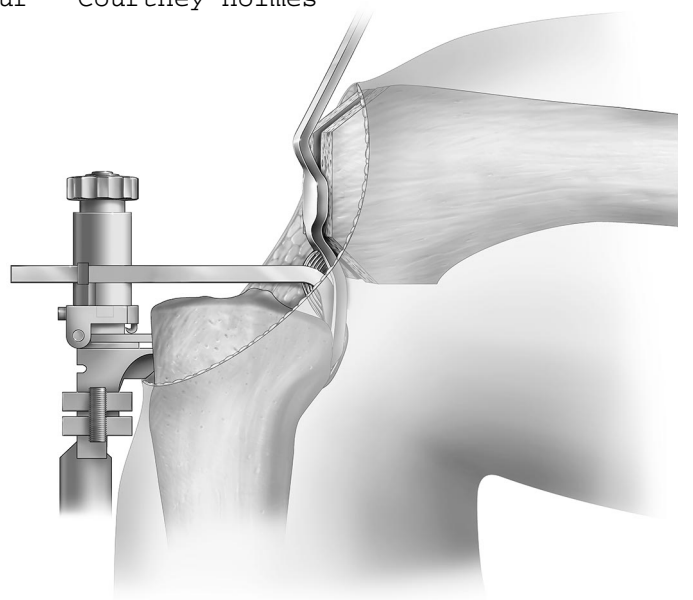

cr08Brev01.psd

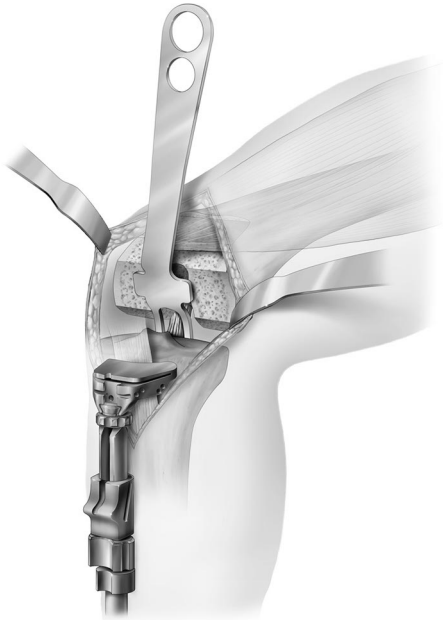

cr09rev01.psd

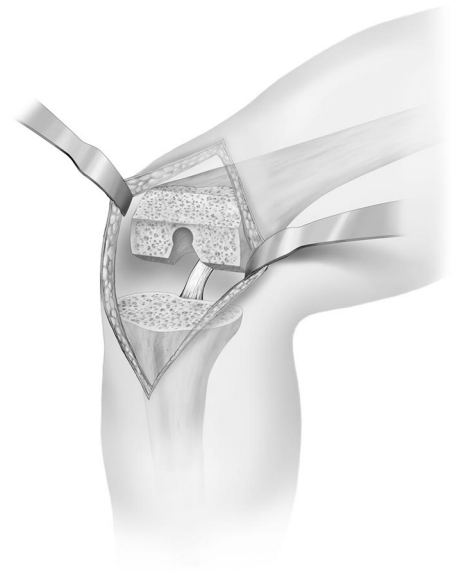

cr10rev01.psd

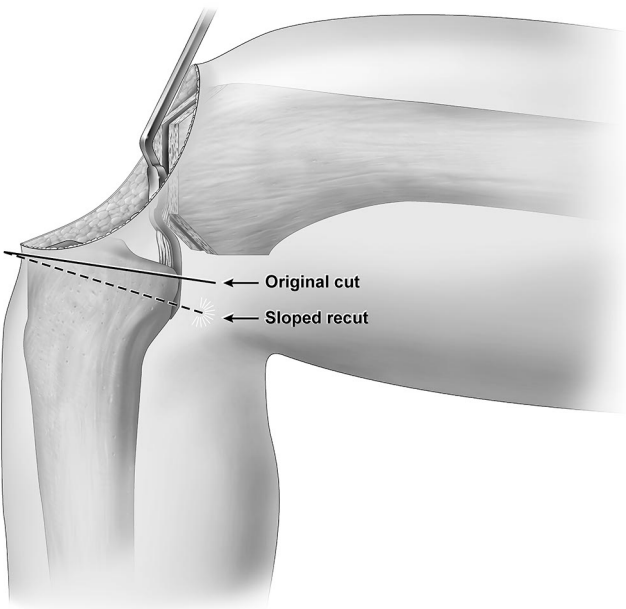

cr12rev01.psd

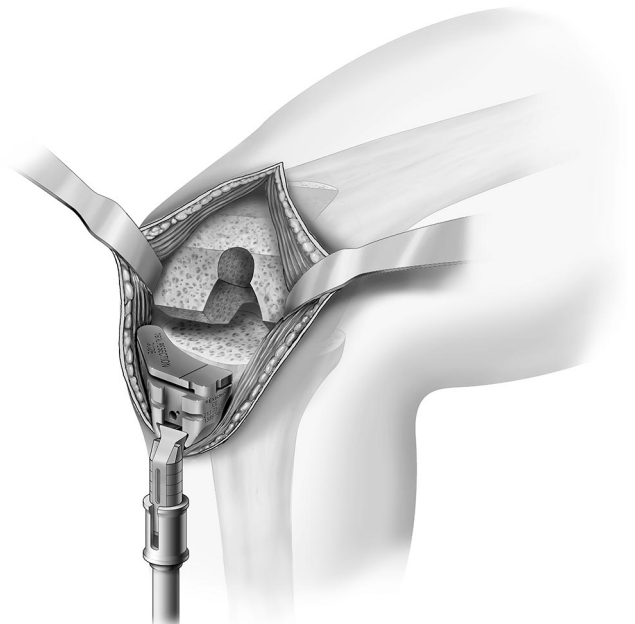

d02rev01.psd



block01.psd



impact_rev01.psd

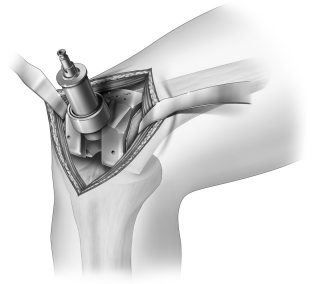

2010 11 logic13c

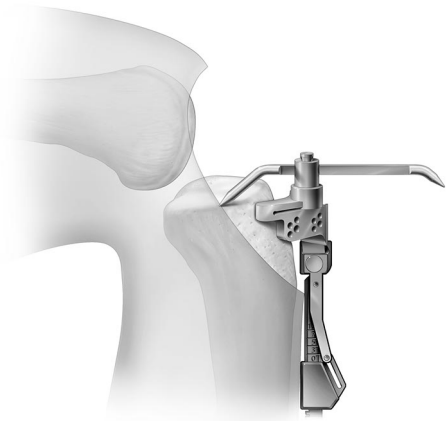

intramed007A_rev01.psd

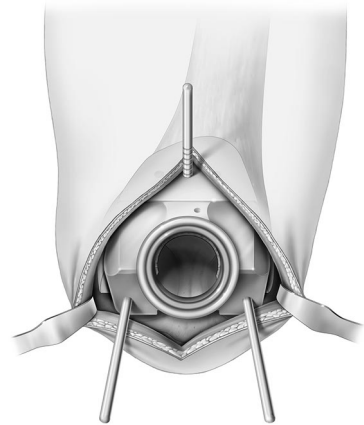

logic23c_rev01.psd



lp19handletray.psd



lpi006rev01.psd

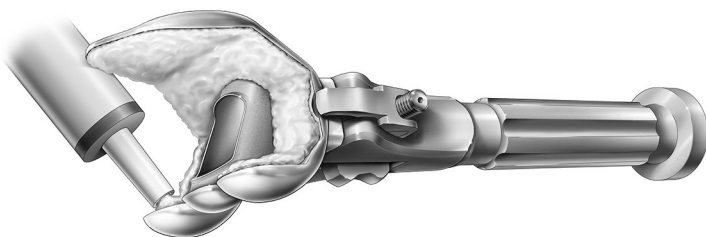

lpi006rev02.psd



striking.psd

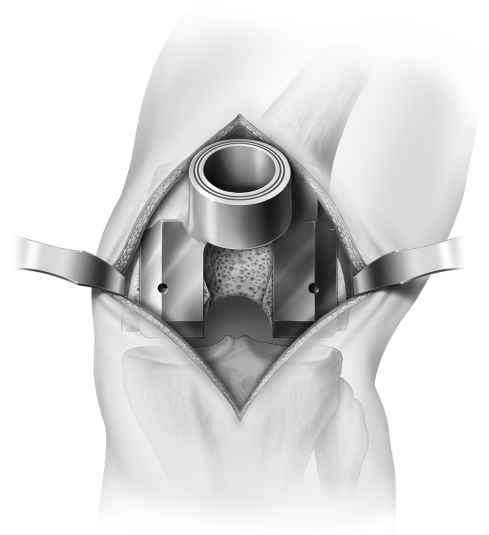

2010 12 notch01



pla01-prev04.jpg



pla02-prev03.jpg

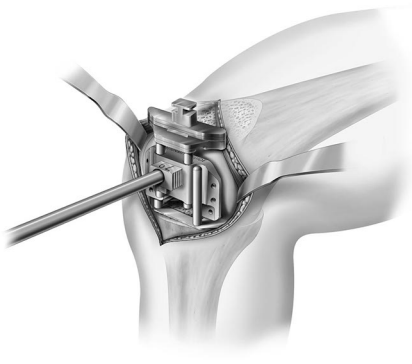

kt01-prev02.jpg

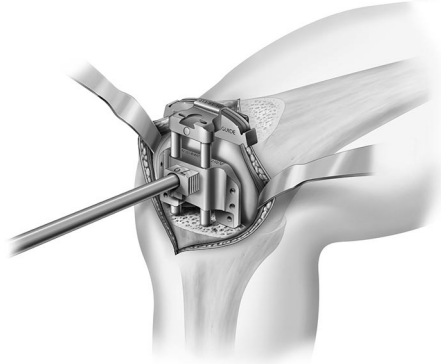

kt02-prev03.jpg



kt03-prev02.jpg

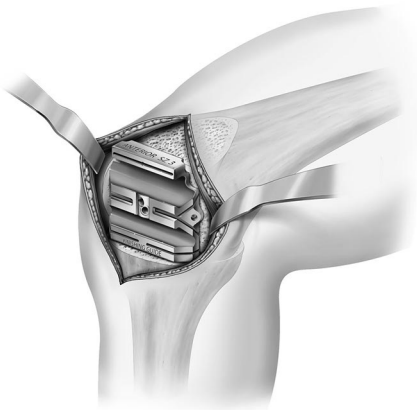

kt04-prev02.jpg

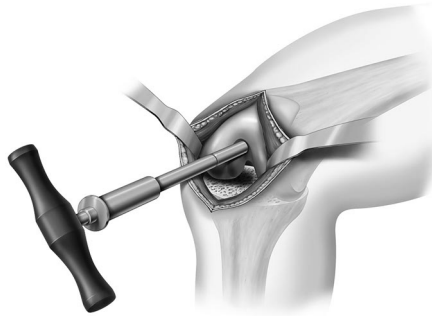

kt05-prev01.jpg

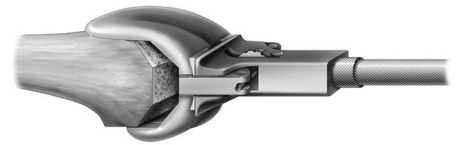

kt06.jpg
fig24E



kt08-prev01.jpg

2010 09
cement question





b_Fig_08rev01.tif

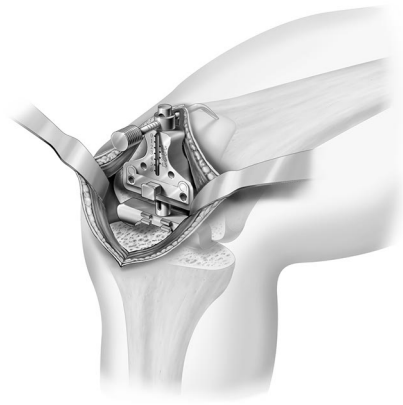

b_Fig_09rev01.tif



logic_cr03.tif



logic_cr04.tif

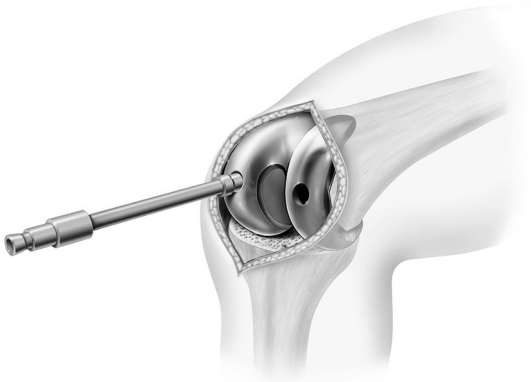

logic_cr04XX.tif



lp15Arev01.tif

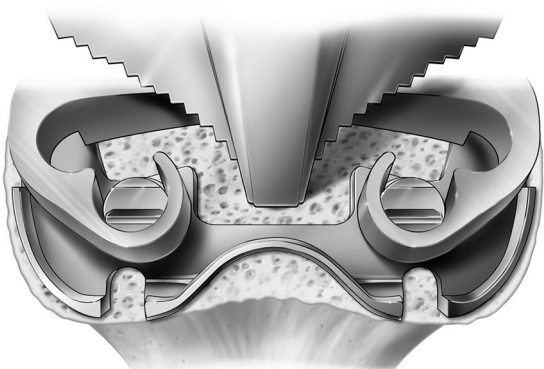

lp16Arev01.tif





b_Fig_08rev01.tif



b_Fig_09rev01.tif



crps01rev01.tif

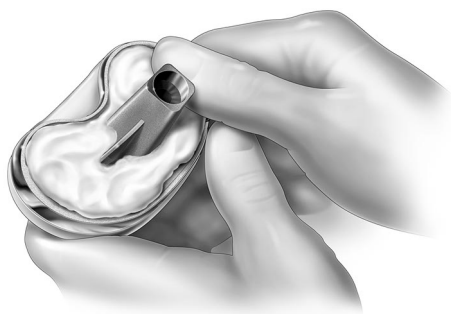

crps02rev01.tif



knee005rev01.tif



logic_cr03.tif



logic_cr04.tif

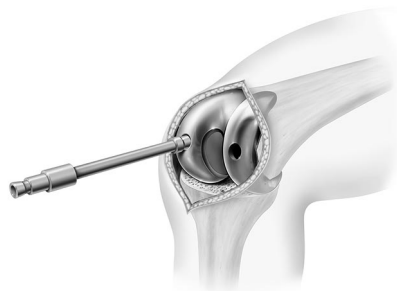

logic_cr04XX.tif

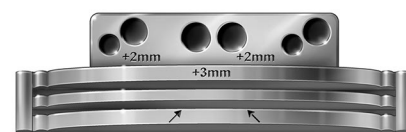

logic_cr08.tif



lp15Arev01.tif

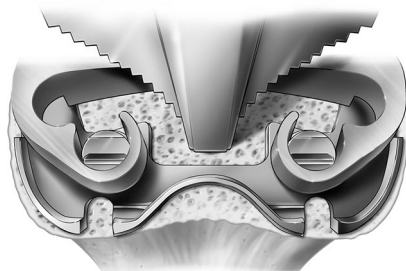

lp16Arev01.tif



lp19handletray_rev01.tif



lpi004rev01.tif



lpi007rev01.tif



striking_rev01.tif

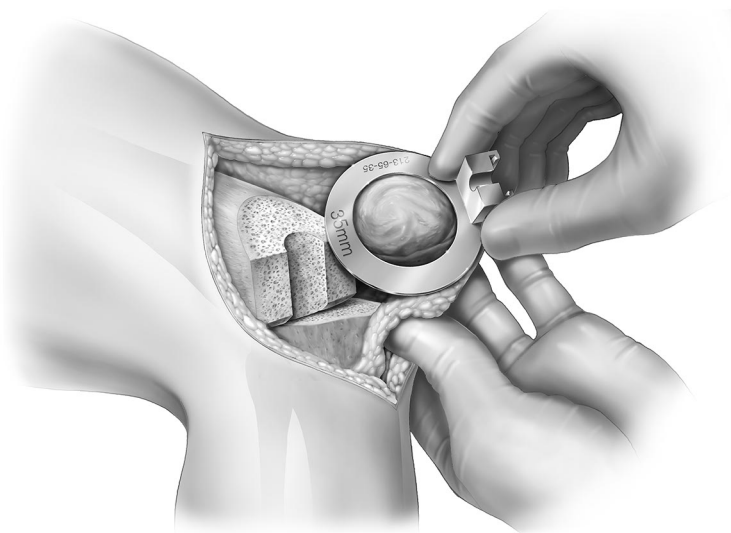

pate01.tif

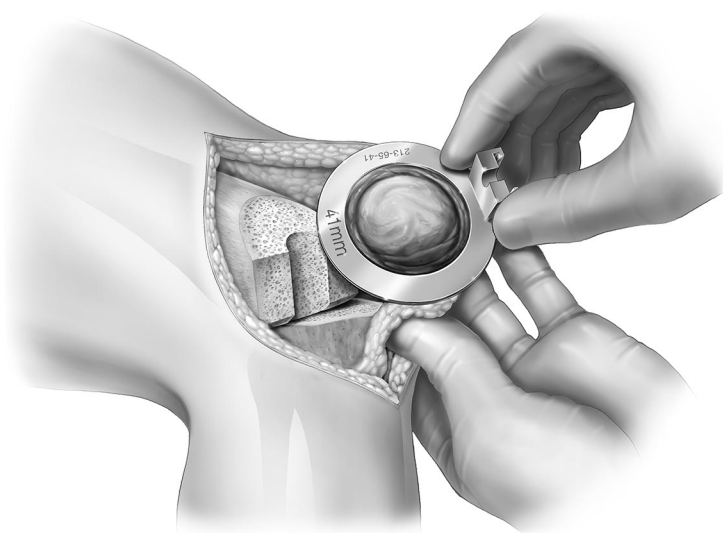

pate02.tif

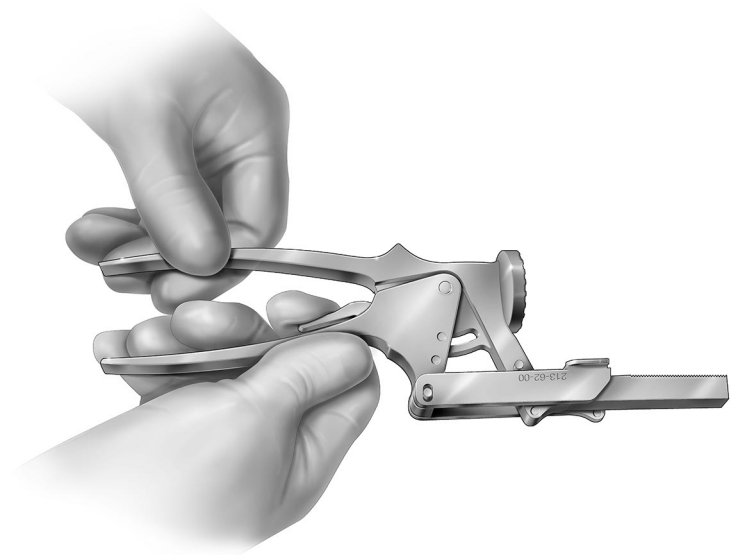

pate03.tif

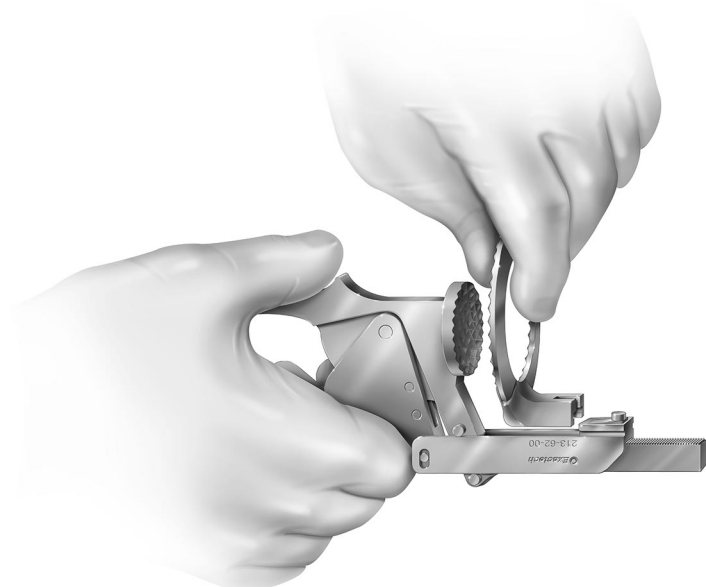

pate04.tif

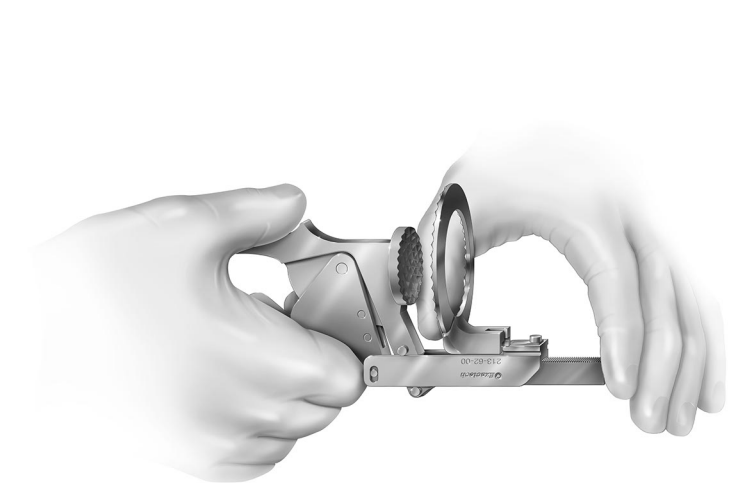

pate04rev1.tif

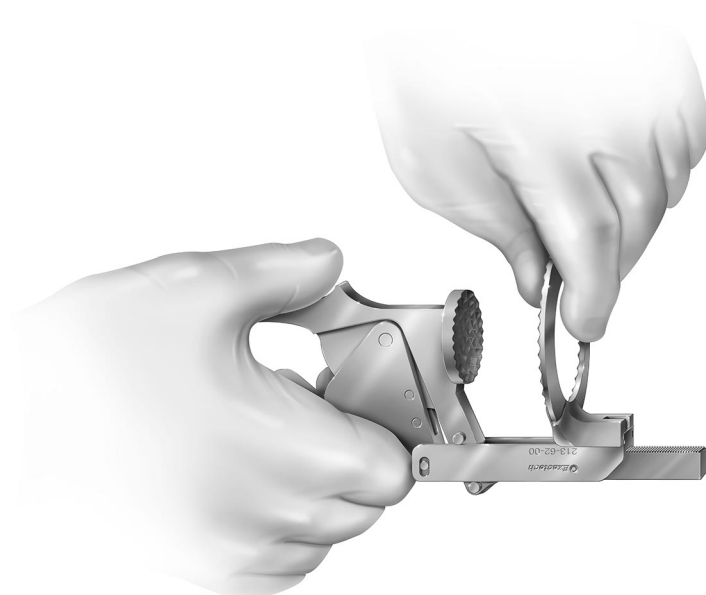

pate05.tif

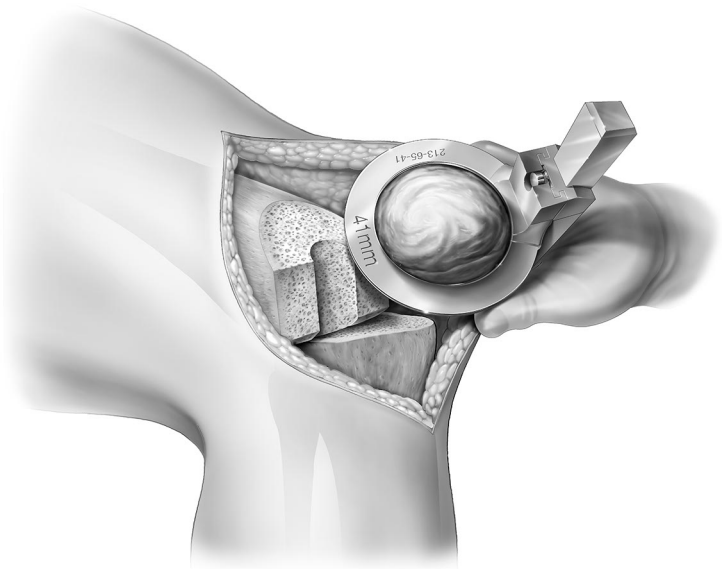

pate06.tif

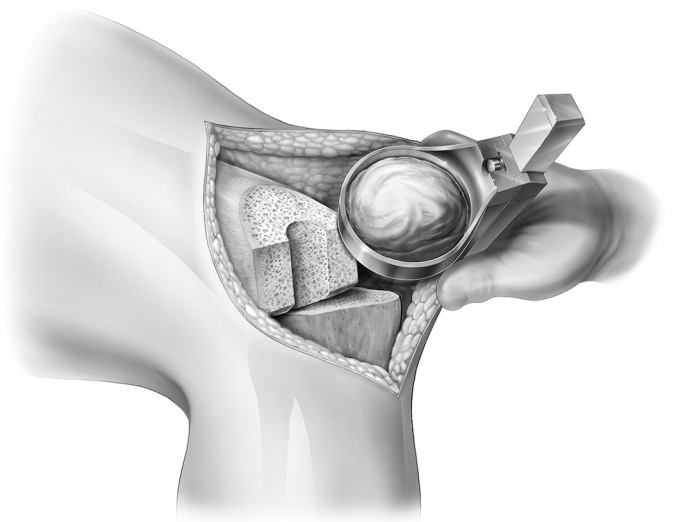

pate06A.tif

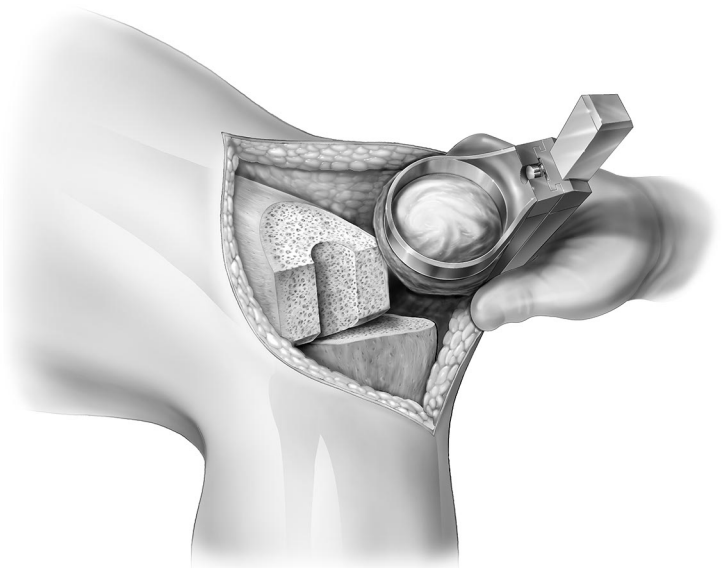

pate06B.tif

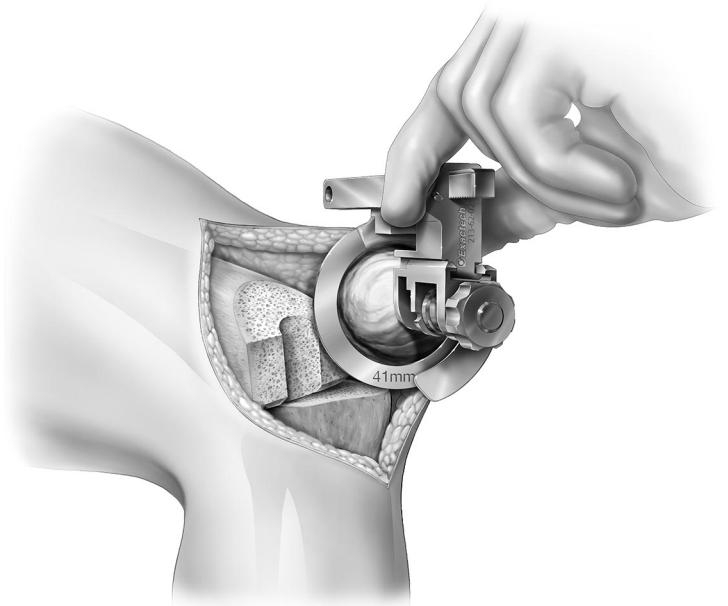

pate07.tif

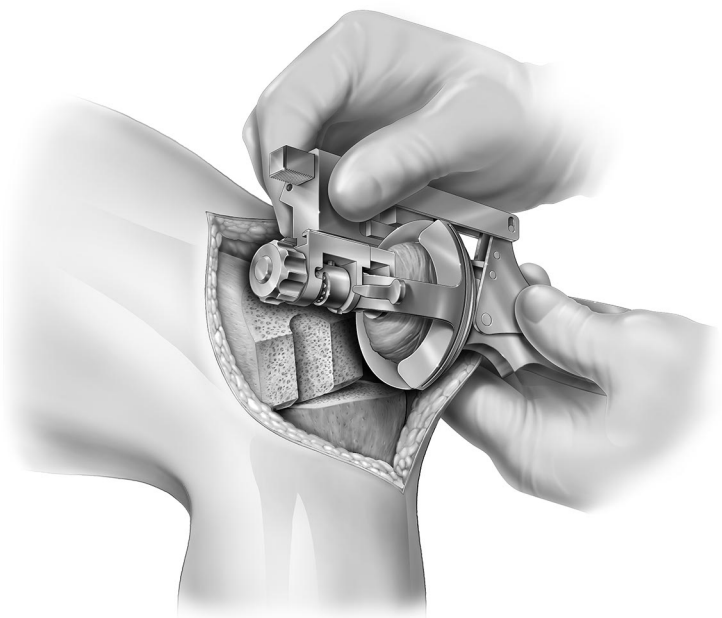

pate08.tif

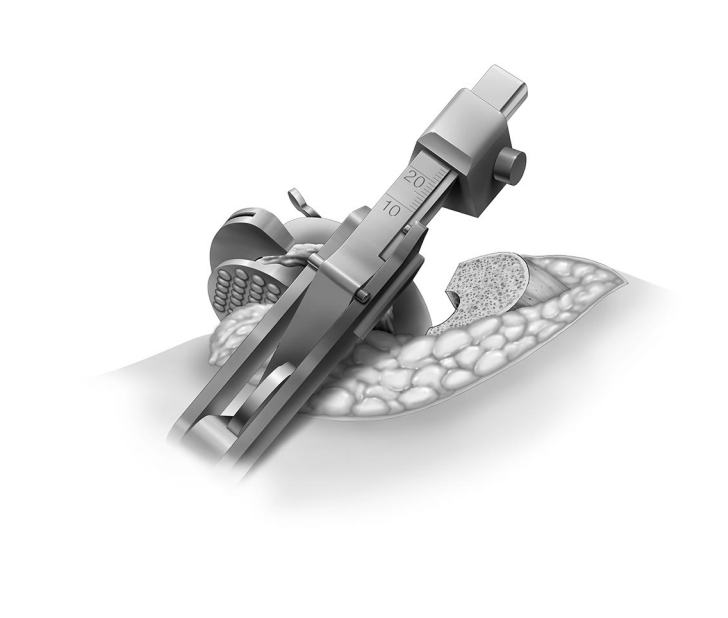

pate09.tif

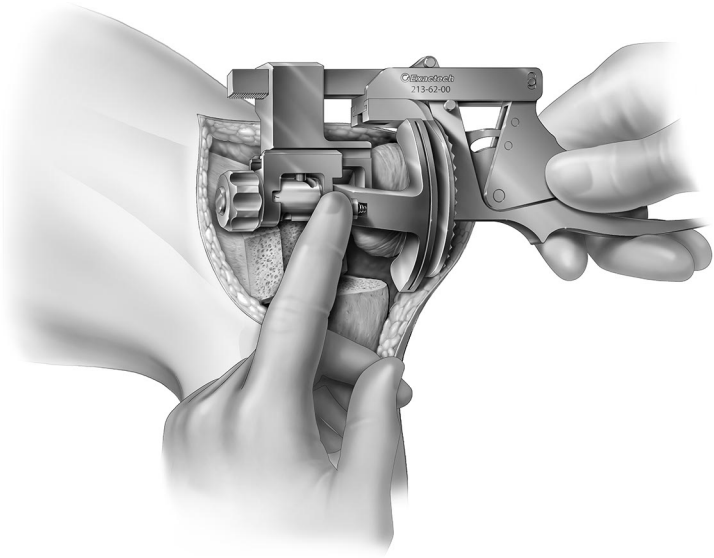

pate10.tif

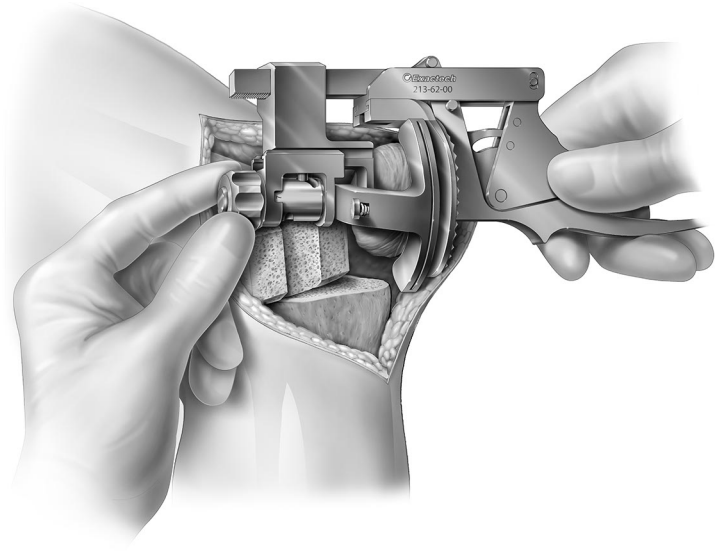

pate11.tif

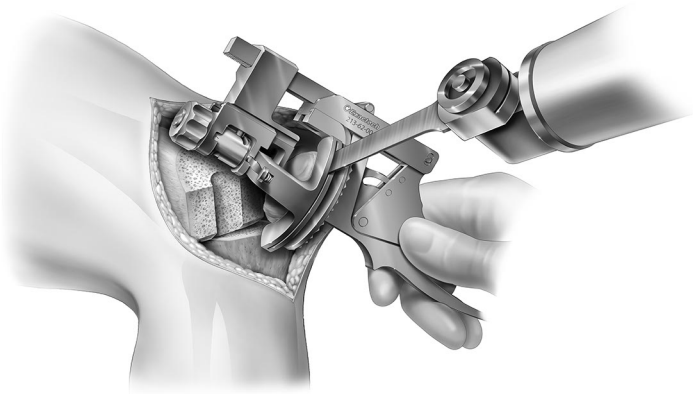

pate12.tif

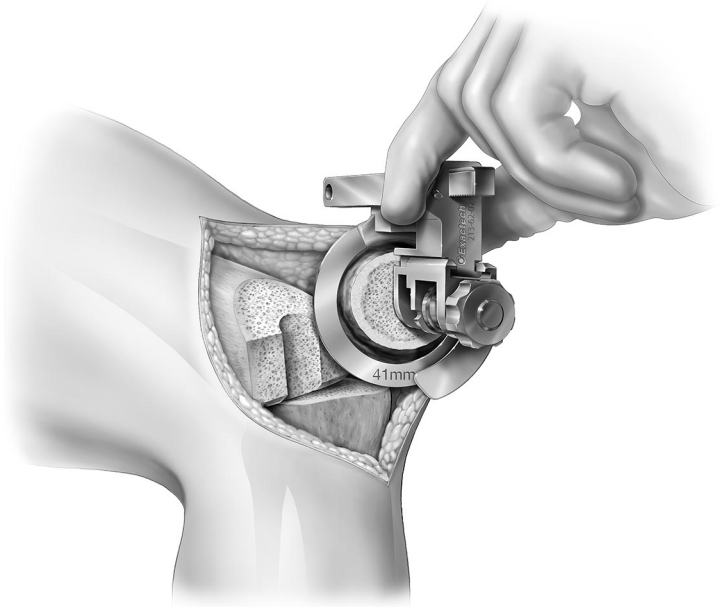

pate13.tif

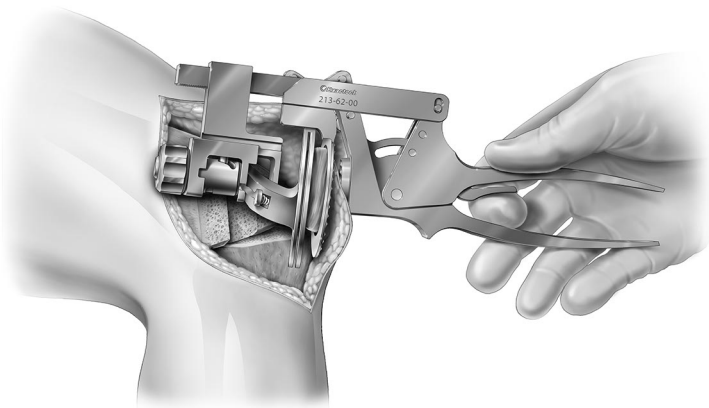

pate14.tif

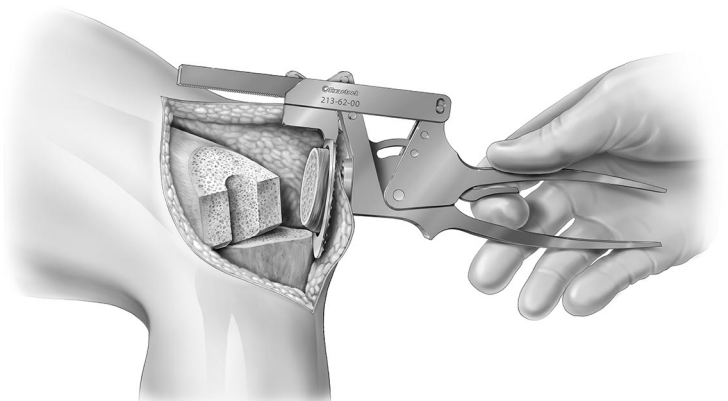

pate14rev1.tif

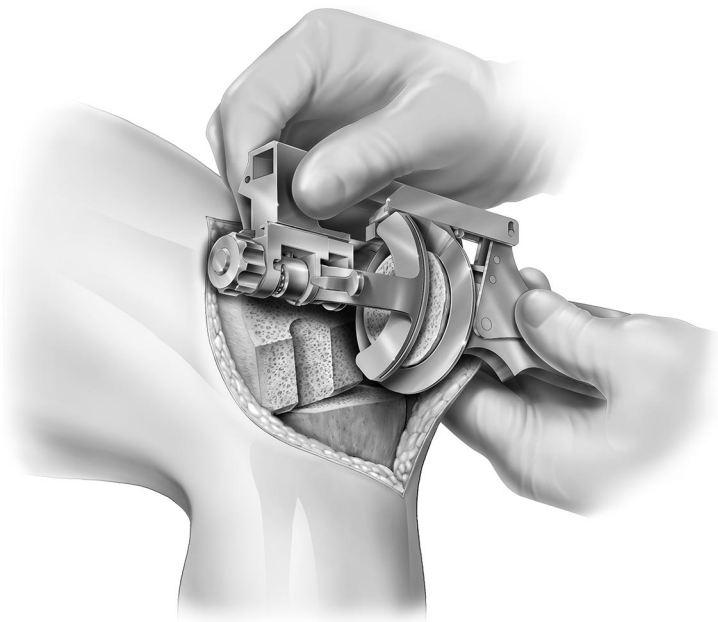

pate15.tif

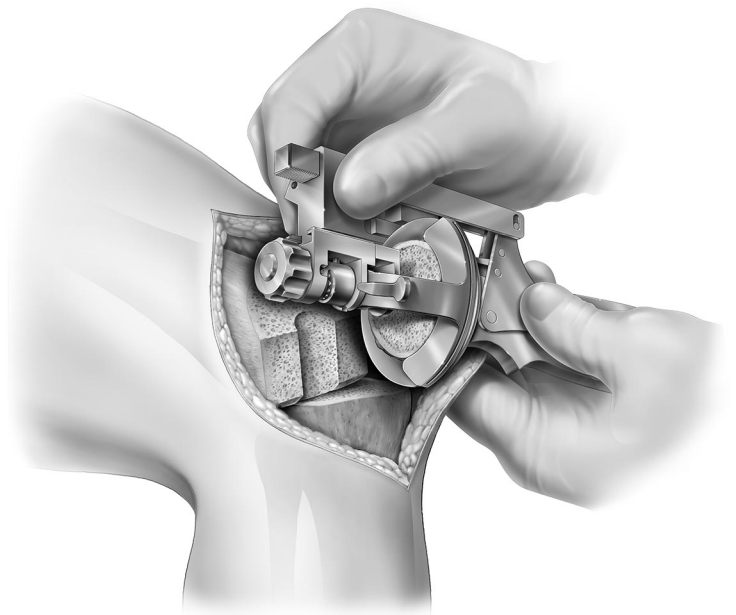

pate16.tif

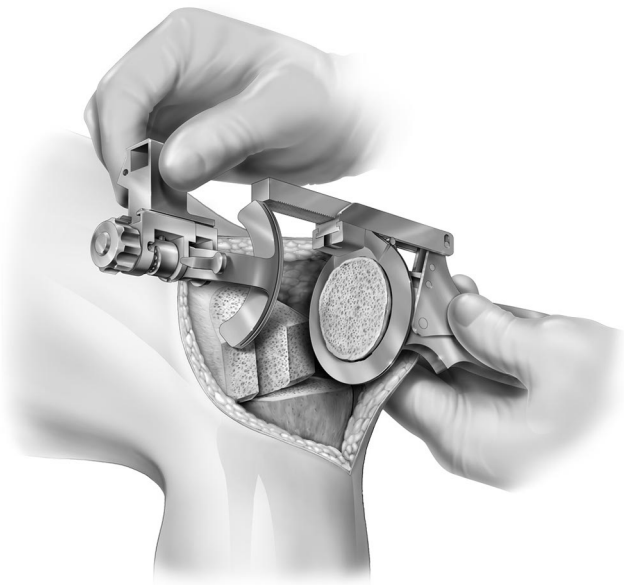

pate17.tif

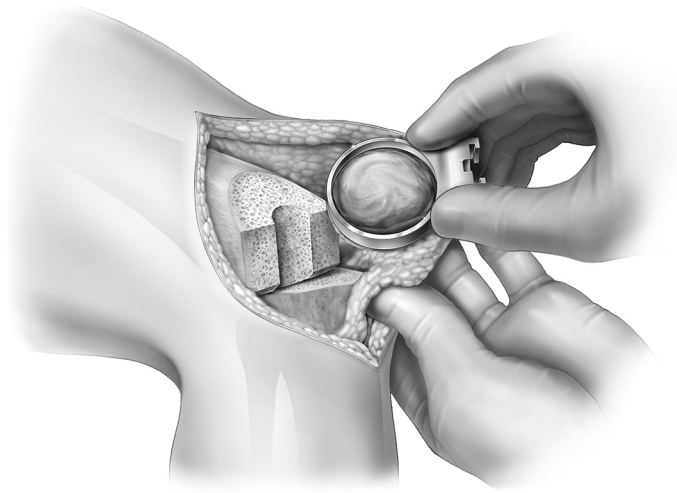

pate18.tif

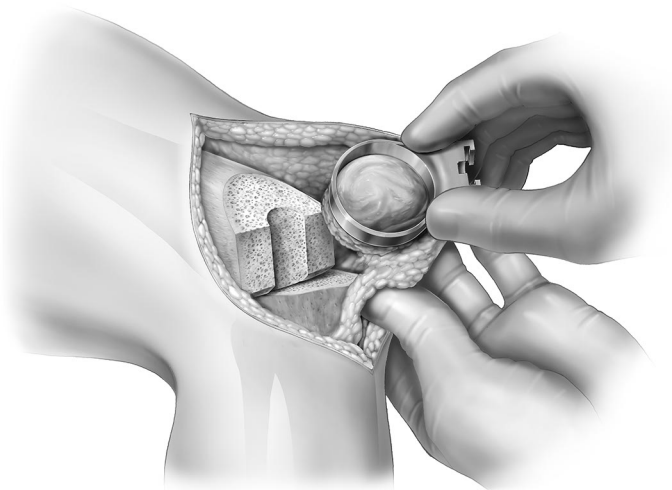

pate18A.tif

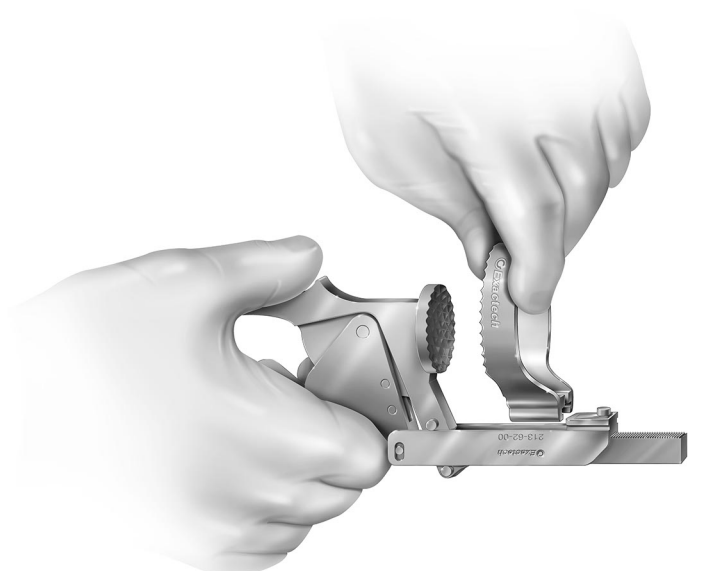

pate19.tif

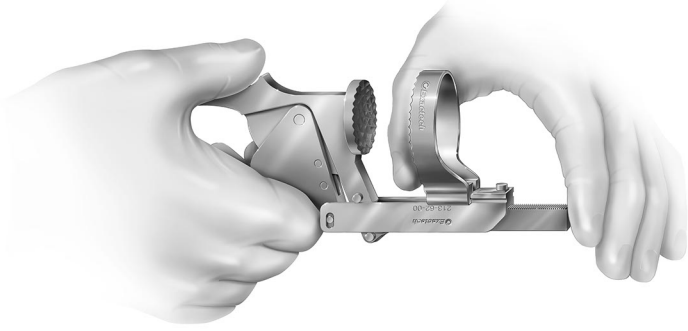

pate19A.tif

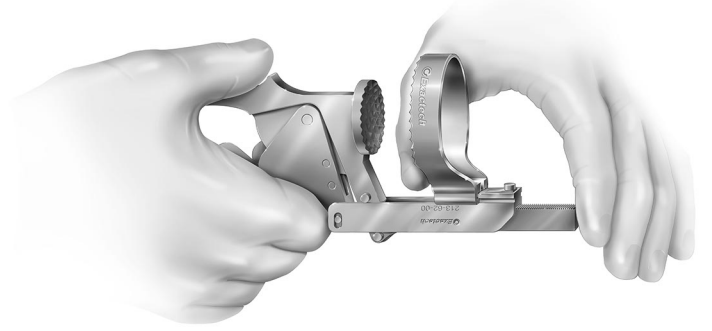

pate19rev1.tif

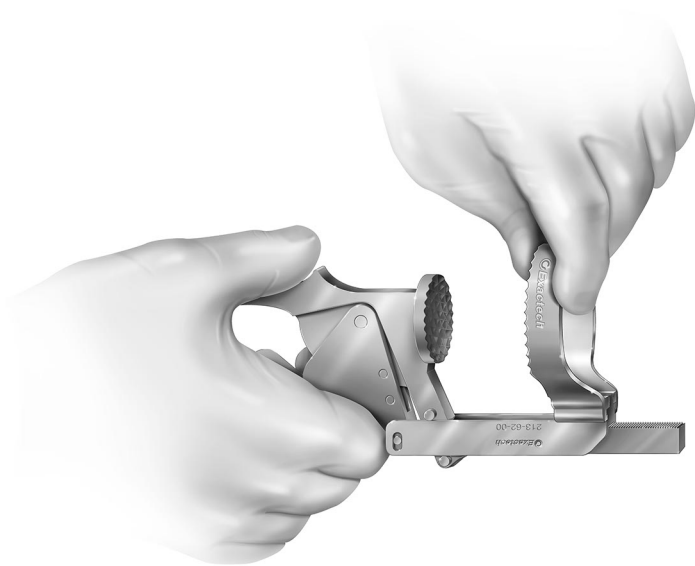

pate20.tif



pate21.tif



pate22.tif



pate23.tif

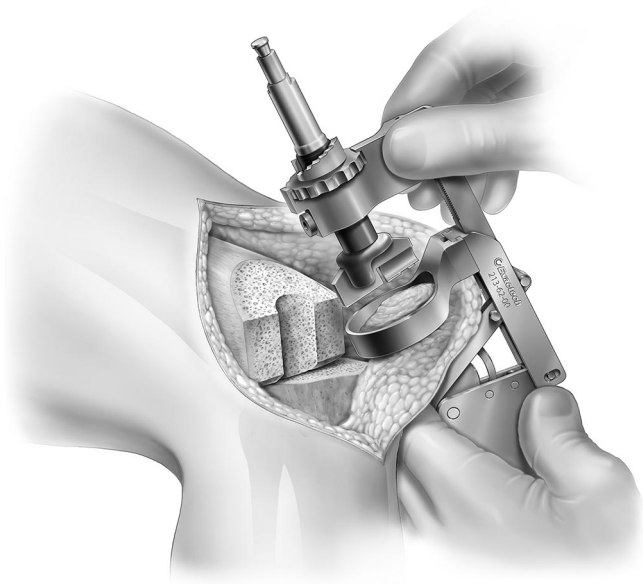

pate24.tif

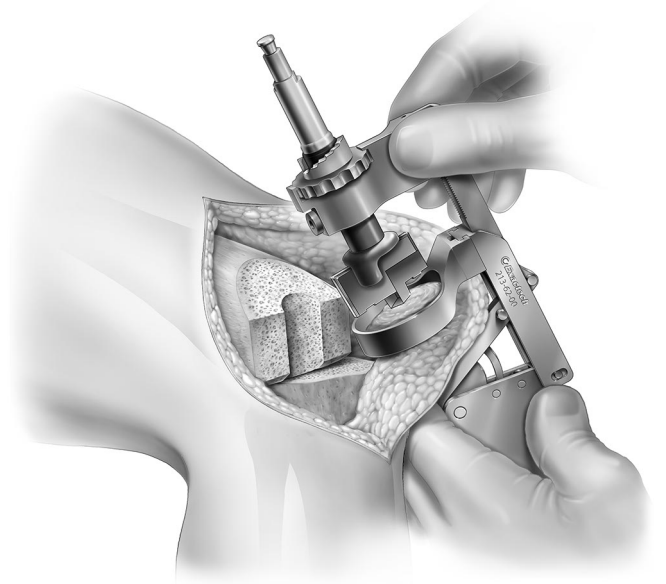

pate24A.tif

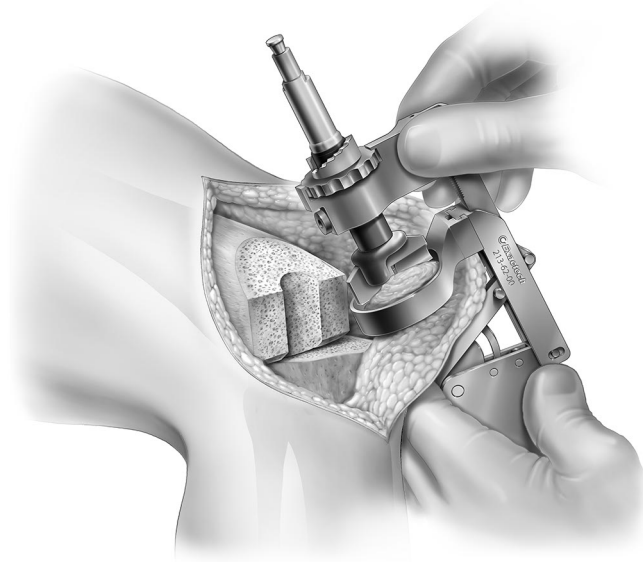

pate25.tif

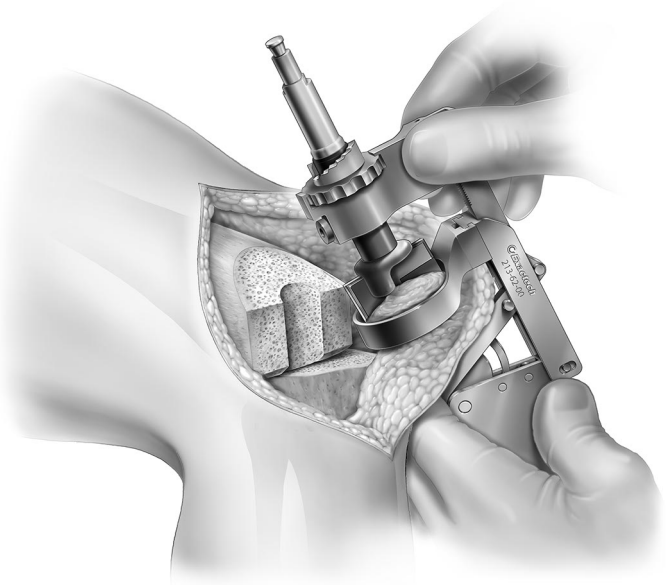

pate25A.tif

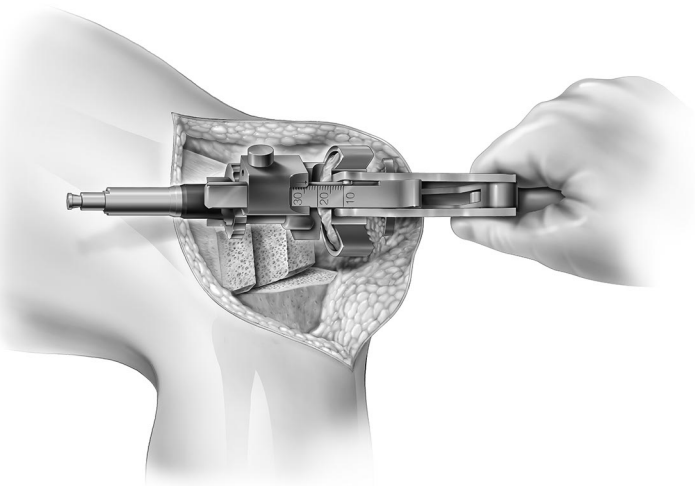

pate26.tif

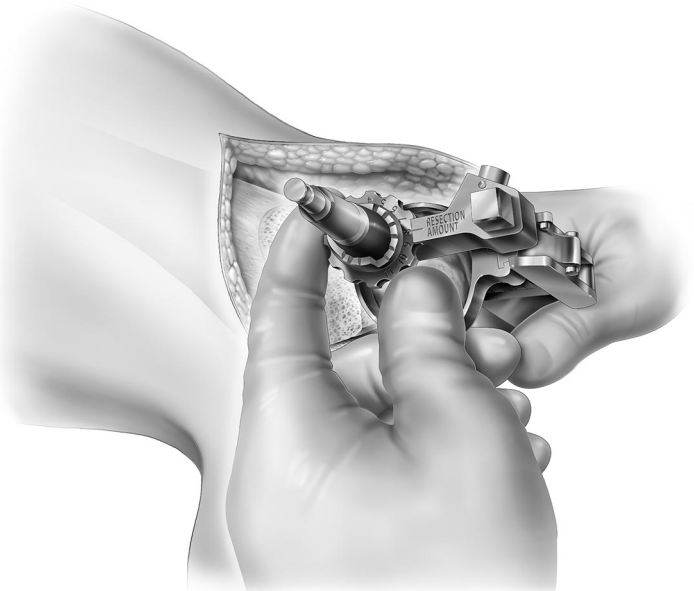

pate27.tif

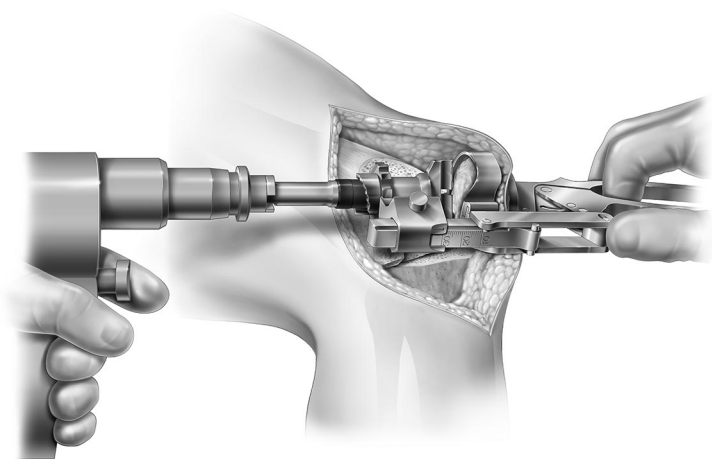

pate28.tif

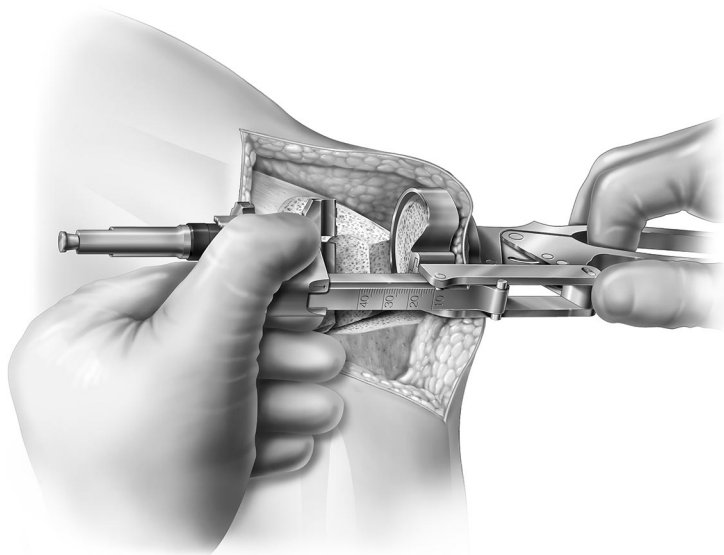

pate29.tif

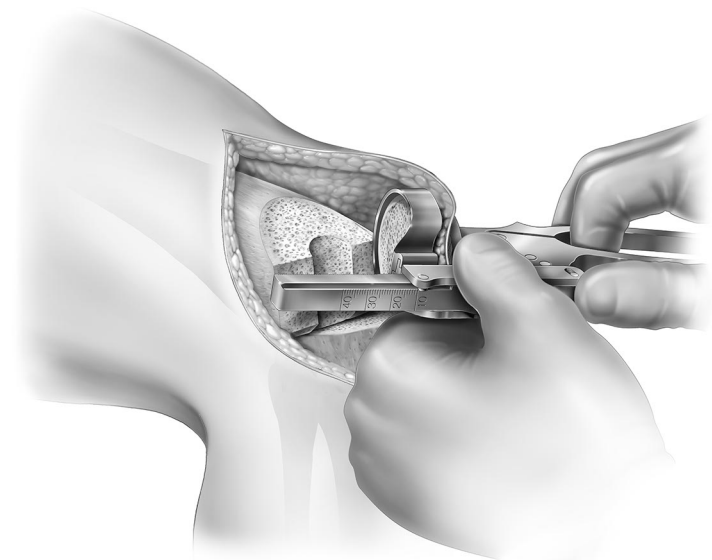

pate30.tif

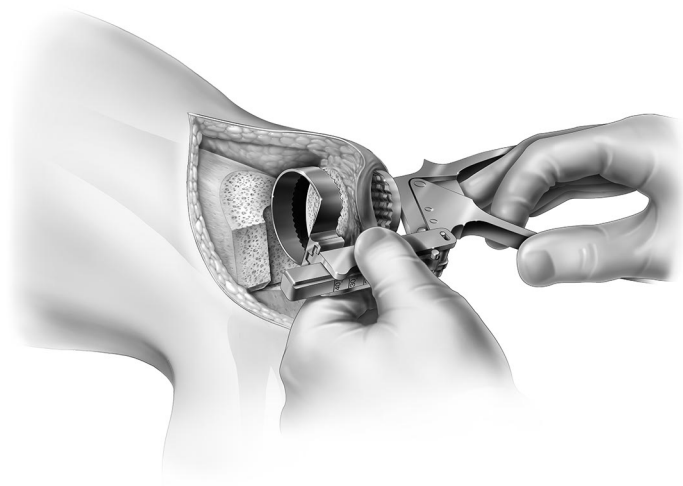

pate31.tif

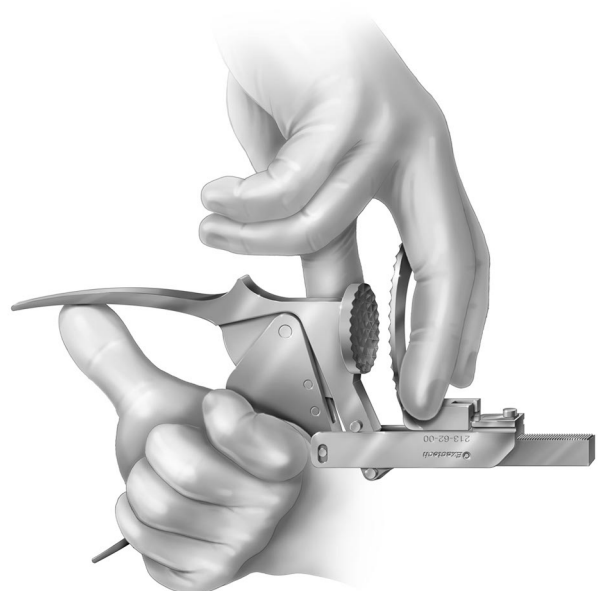

pate32.tif

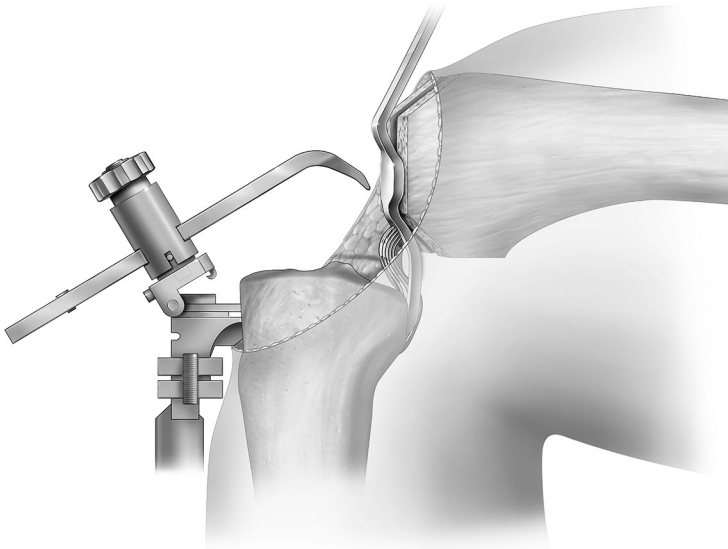

cr08Brev02.tif

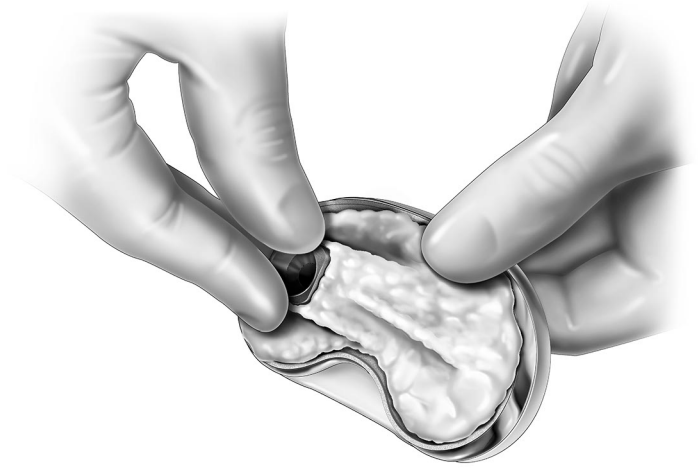

crps04rev02.tif

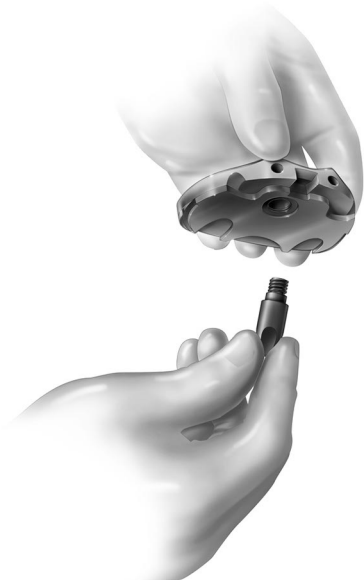

op011rev1.tif

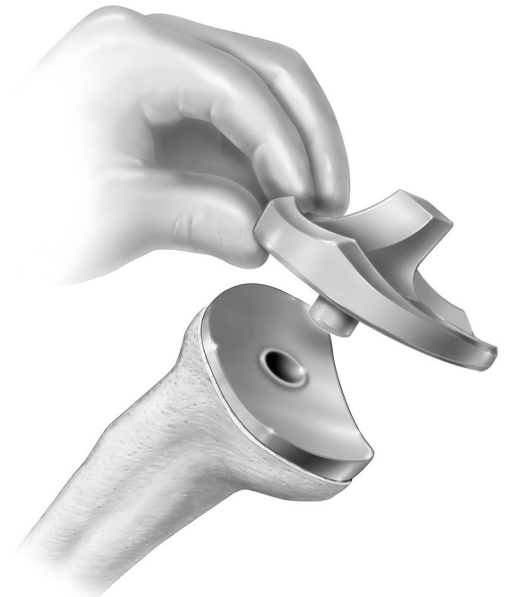

op012rev1.tif



op014Brev1.tif

ps20111025stem



knee011rev1v



striking-rev2stem



2011 11 02 Hex Driver
knee006a_hex

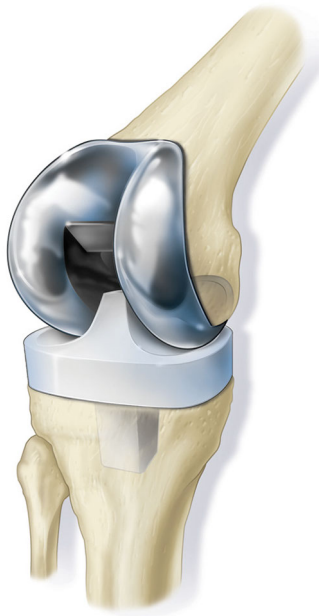

eib_1-prev.jpg

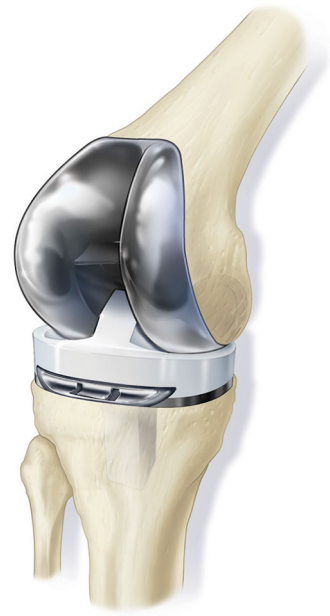

eib_2-prev.jpg

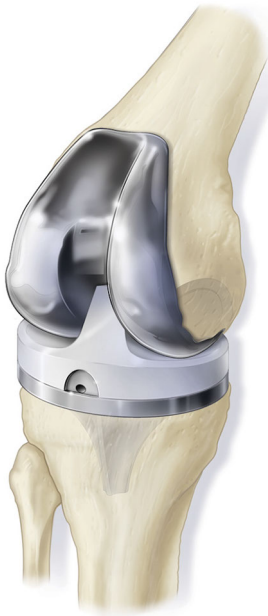

eopt-prev.jpg



eoptlog-prev.jpg

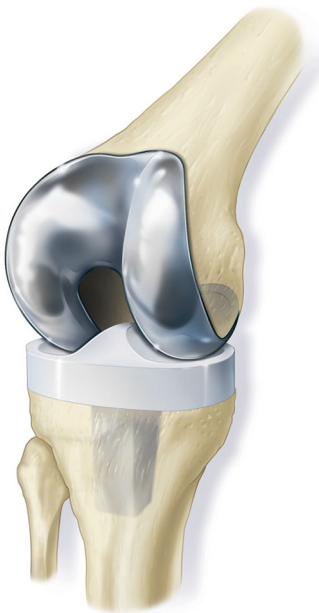

etotcon-prev.jpg

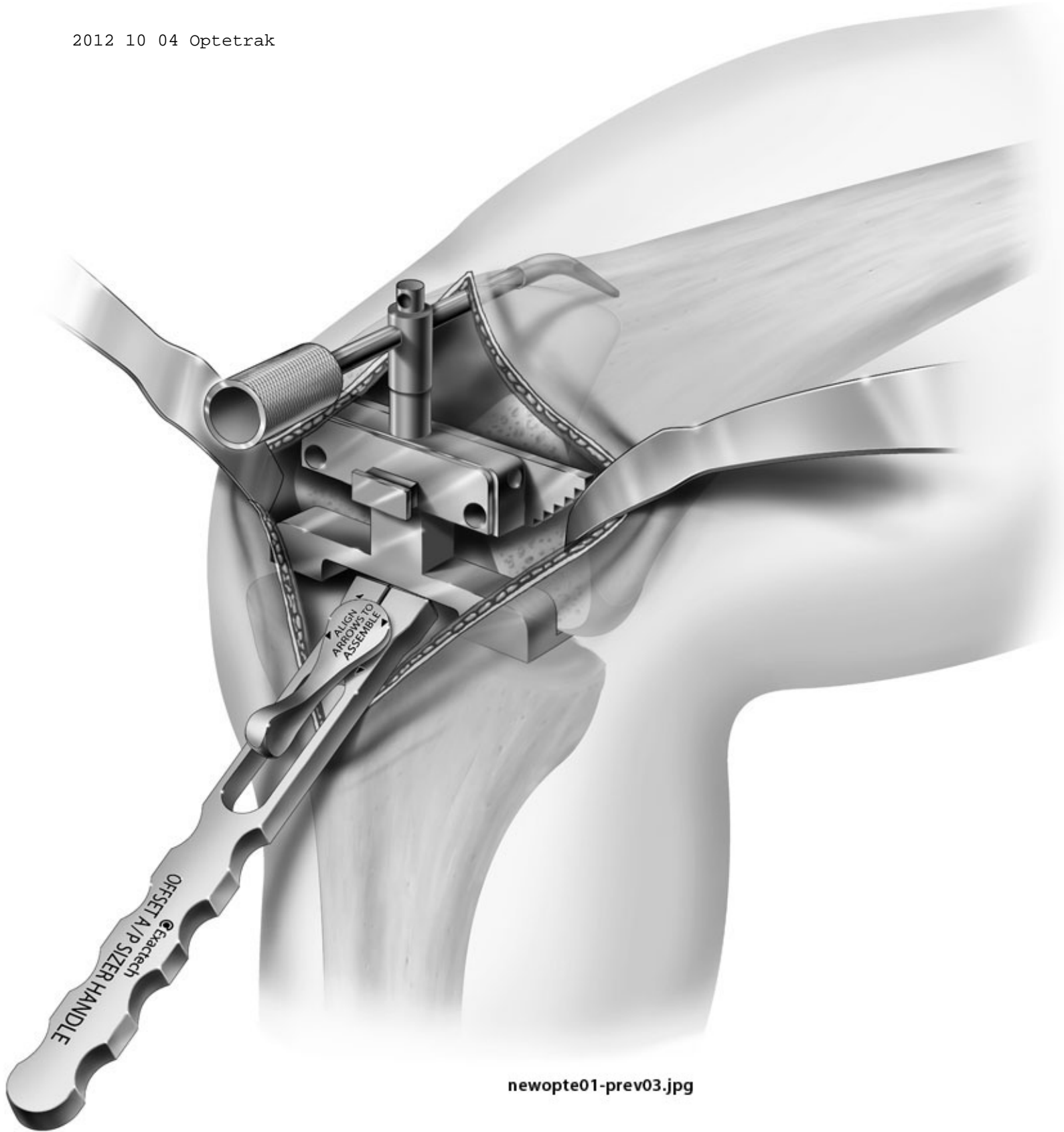

2013 03 26 Ipi006 rev02

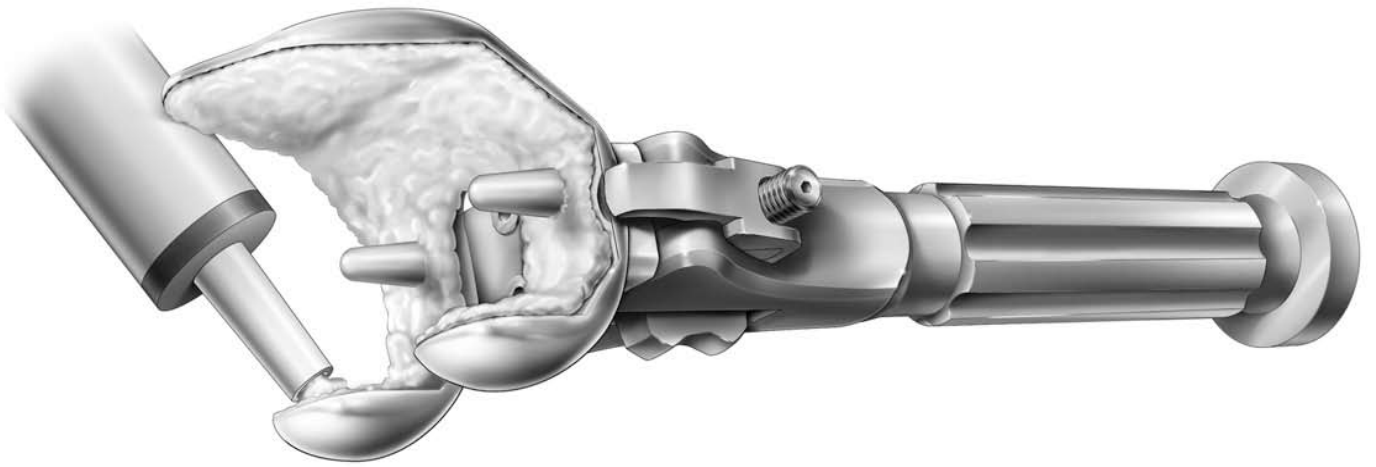

ps 2012 11 26 CRC Logic Courtney Holmes



crclogic01.tif



crclogic02.tif



insert01-prev02.jpg

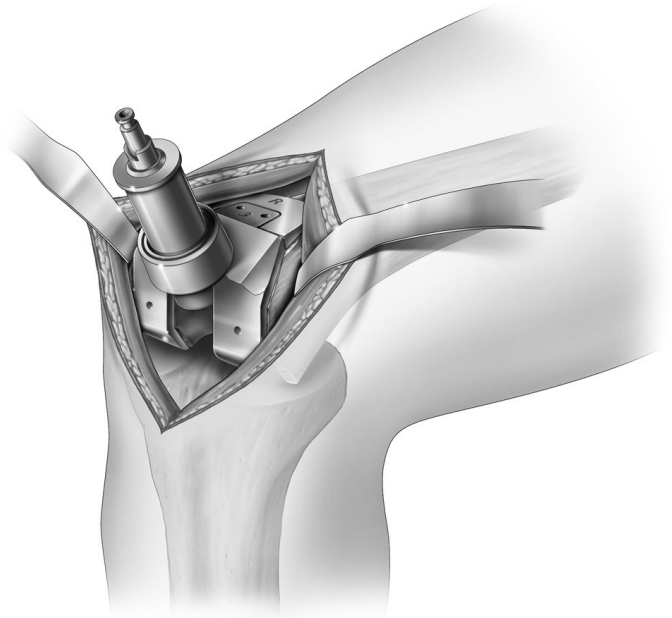

logic13c_rev1-prev01.jpg



newopte01_rev1A-prev04.jpg

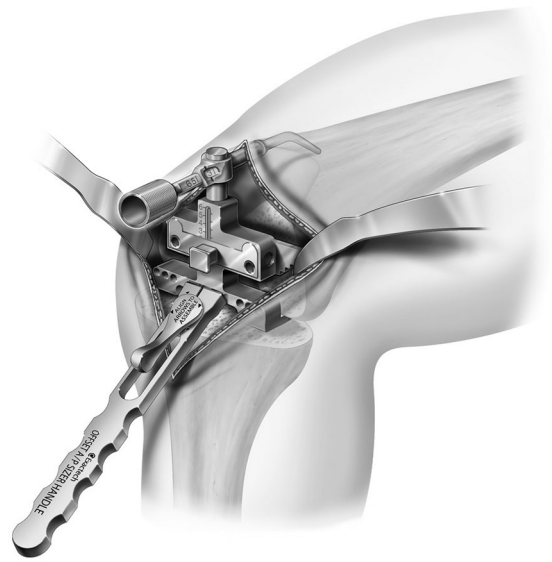

newopte01_rev1B-prev04.jpg



opguide-prev02.jpg

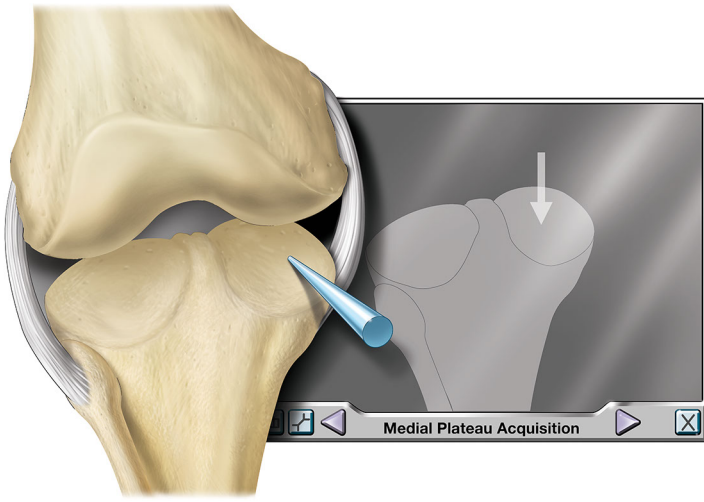

gps_tracker_mct01.tif

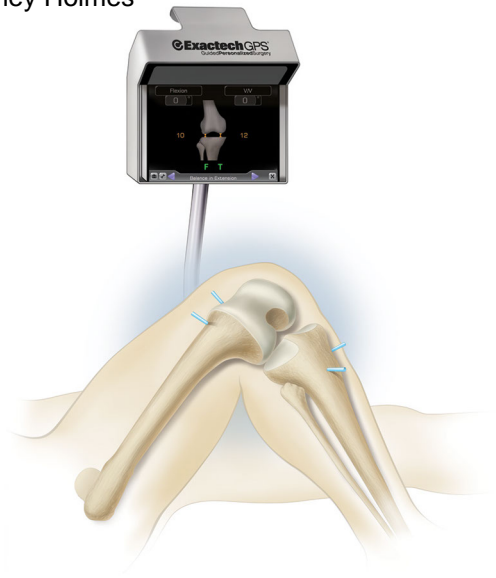

gpstracker-no_rays.tif

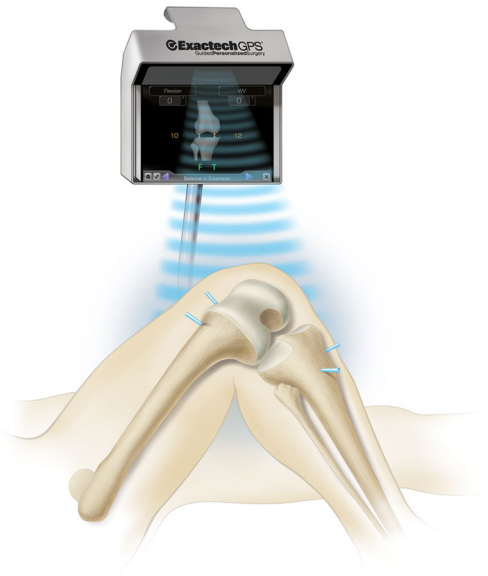

gpstracker-rays.tif



kneeArt04arthrit.tif

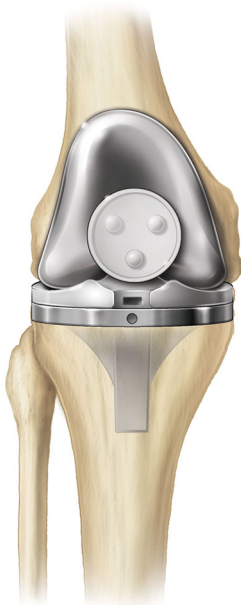

kneeArt04implant.tif



kneeArt04norm.tif

An Arthritic Knee

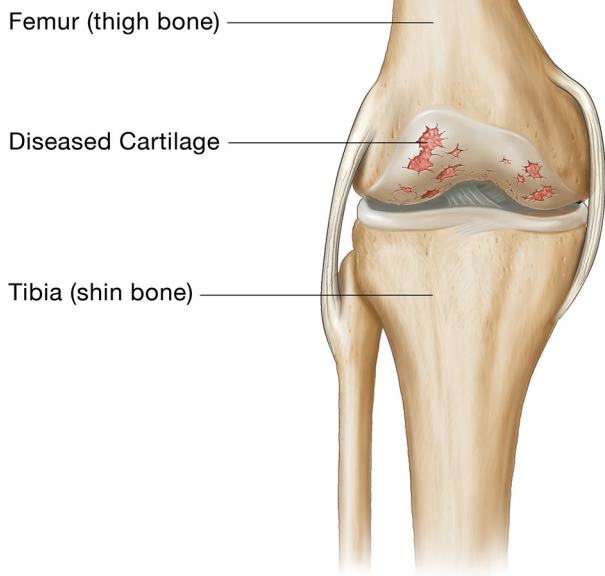

kneeArt04y_athrit.tif

A Normal Knee

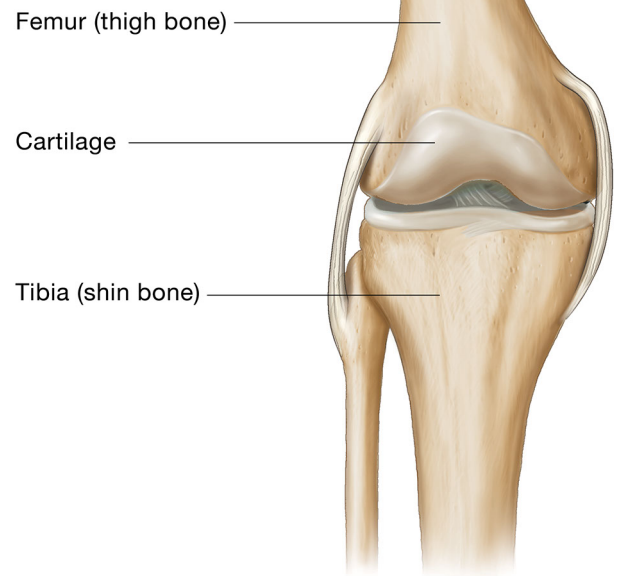

kneeArt04y_normal.tif

A Normal Knee

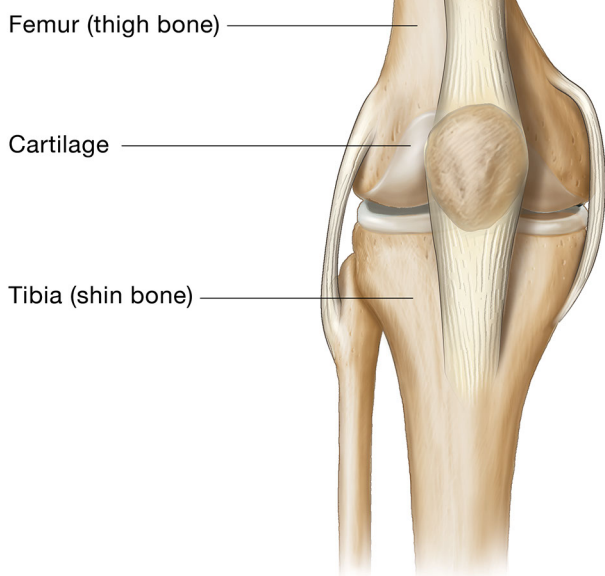

kneeArt04y_rev1.tif

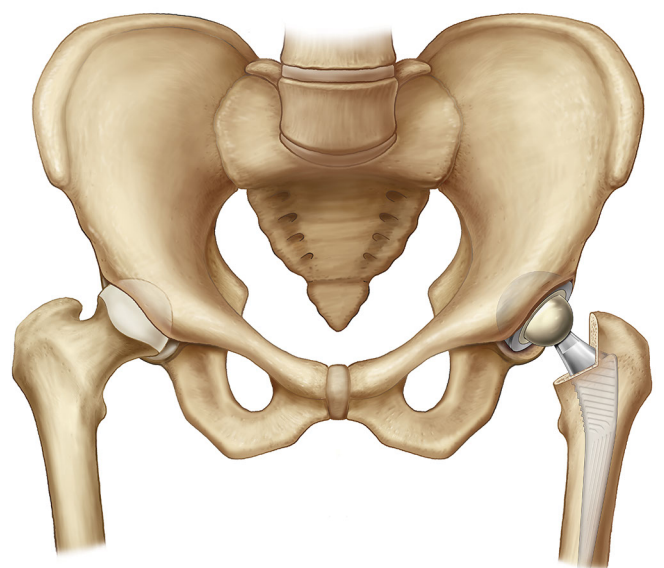

nr06rev02.tif

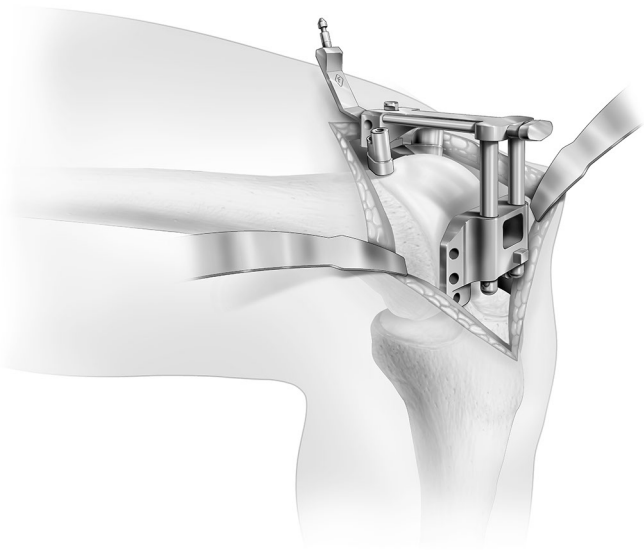

gps001.tif



gps002.tif



gpstibia01.tif



gpstibia02.tif



gpstibia02A.tif

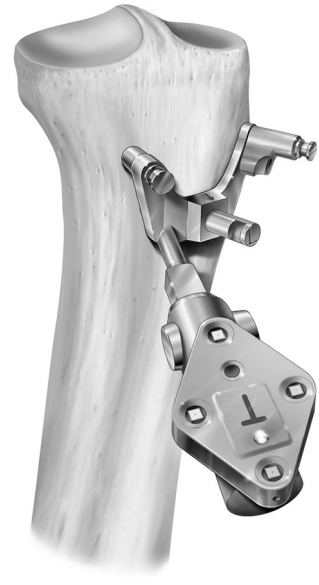

gpstibia03.tif

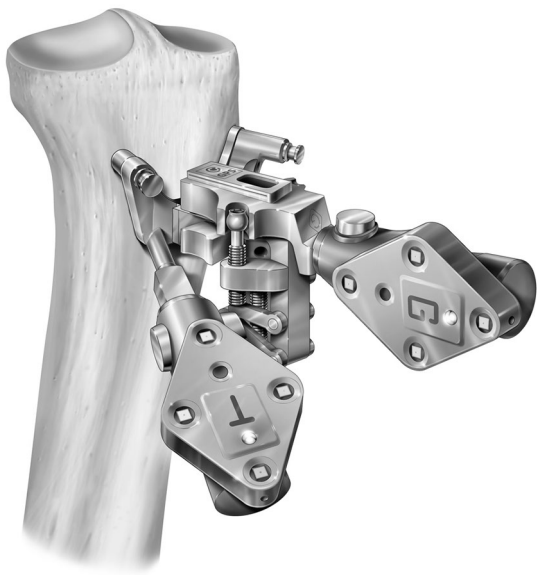

gpstibia04.tif



gpstibia05.tif

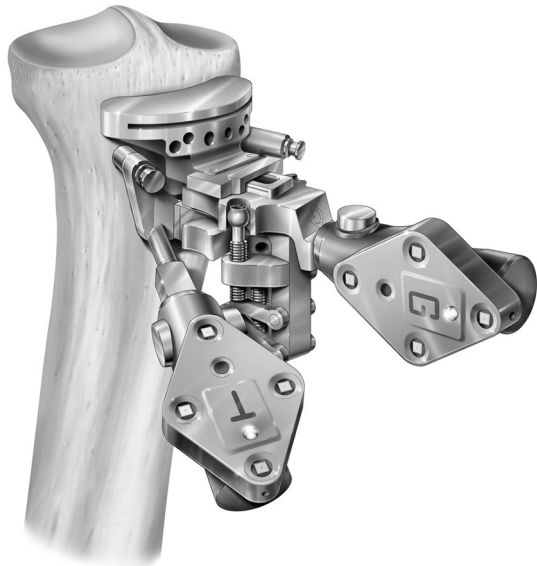

gpstibia06.tif

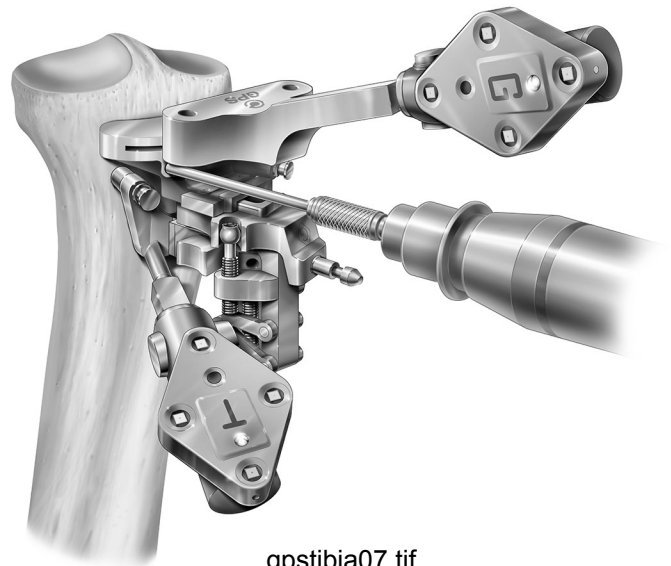

gpstibia07.tif

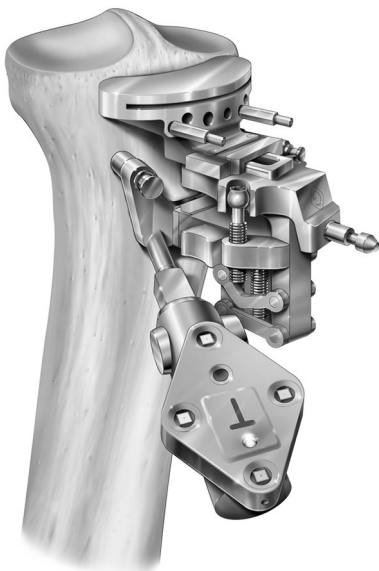

gpstibia08.tif

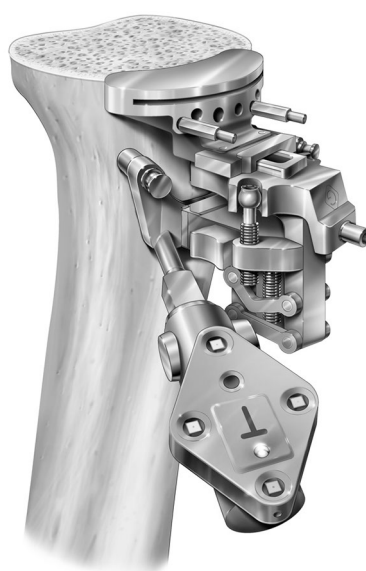

gpstibia09.tif



gpstibia10.tif



gpsfemur02.tif



gpsfemur03.tif

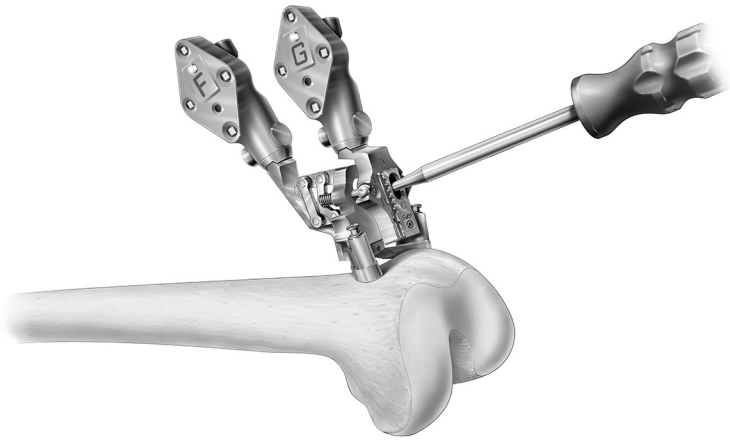

gpsfemur04.tif

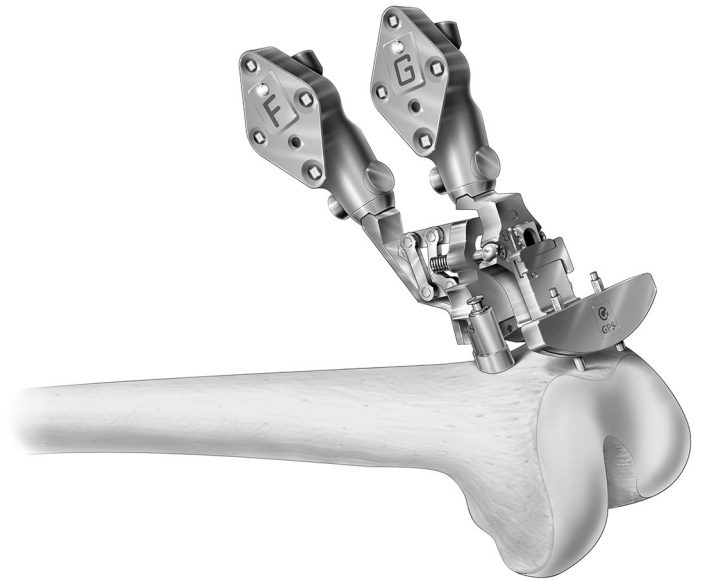

gpsfemur05.tif

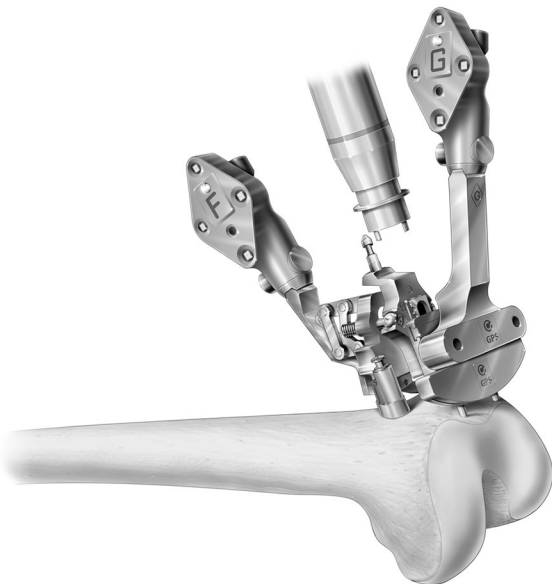

gpsfemur06.tif



gpsfemur07.tif

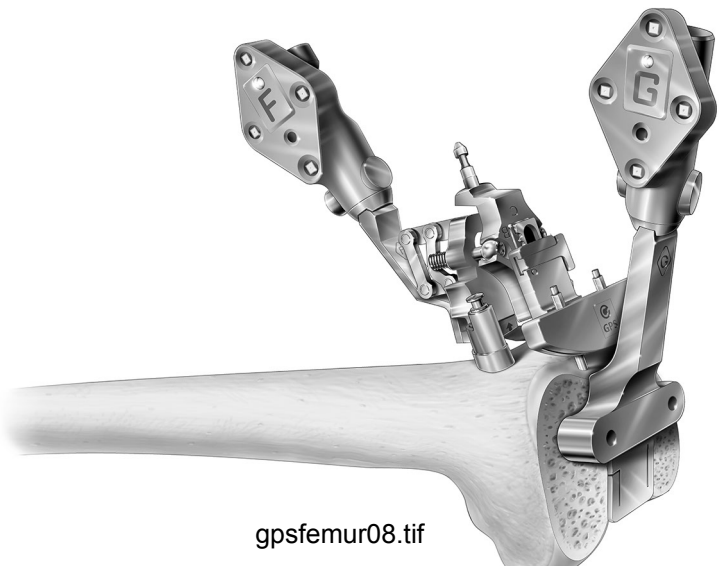

gpsfemur08.tif

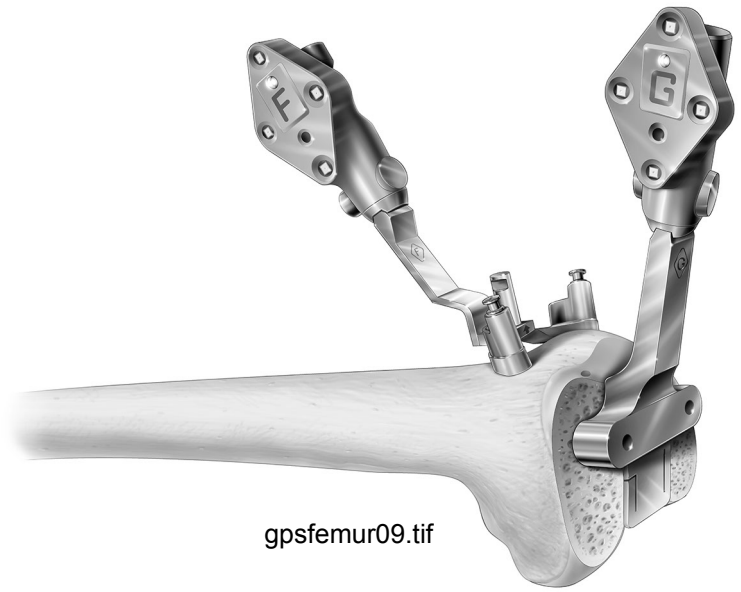

gpsfemur09.tif

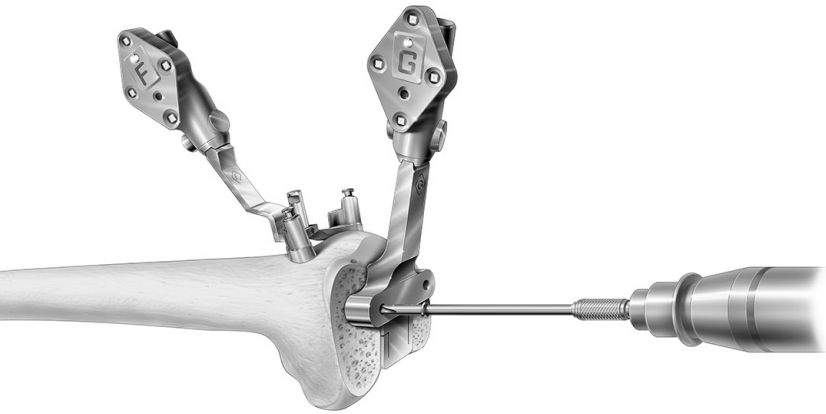

gpsfemur10.tif



2013 12 20 gpsbattery.tif

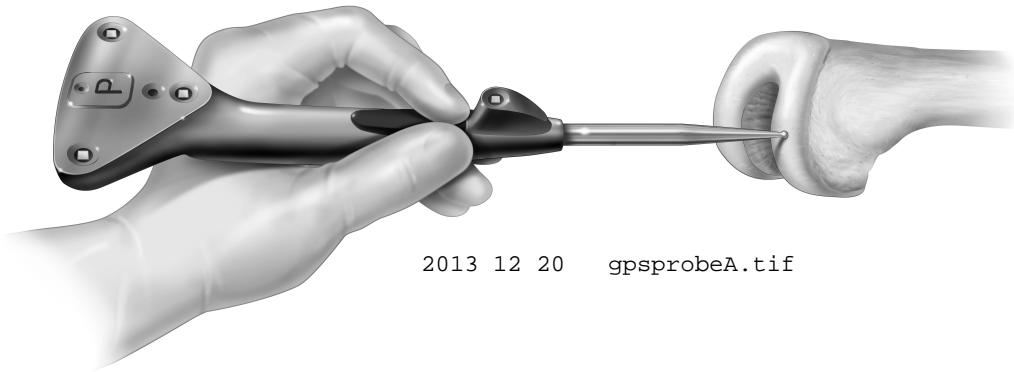

2013 12 20 gpsprobeA.tif

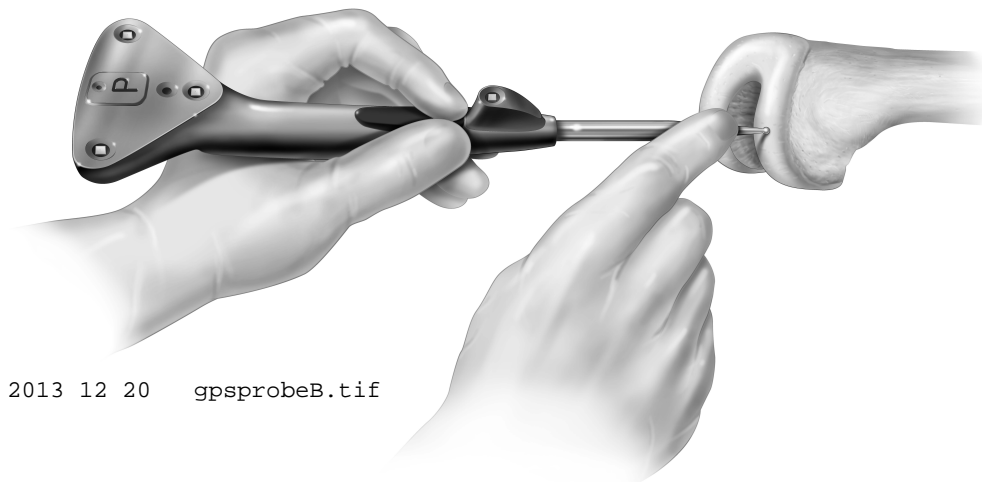

2013 12 20 gpsprobeB.tif



ligsta01.tif

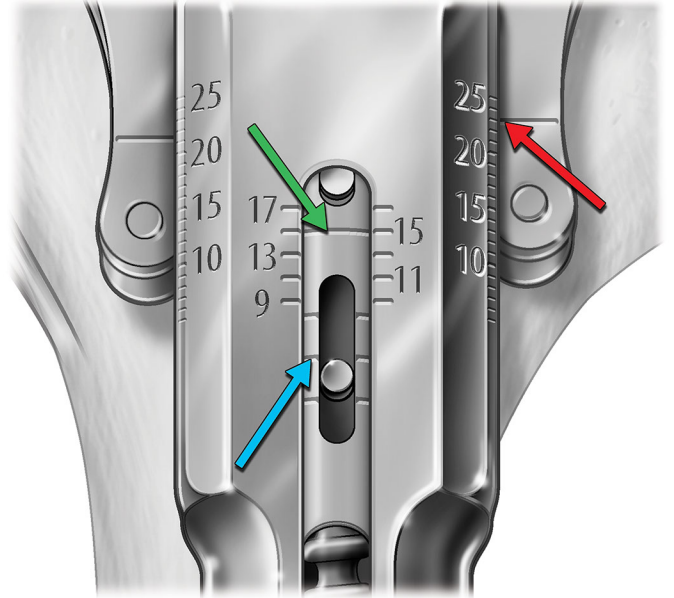

ligsta02.tif



ligsta03.tif



ligsta04.tif



ligsta06.tif



ligsta07.tif

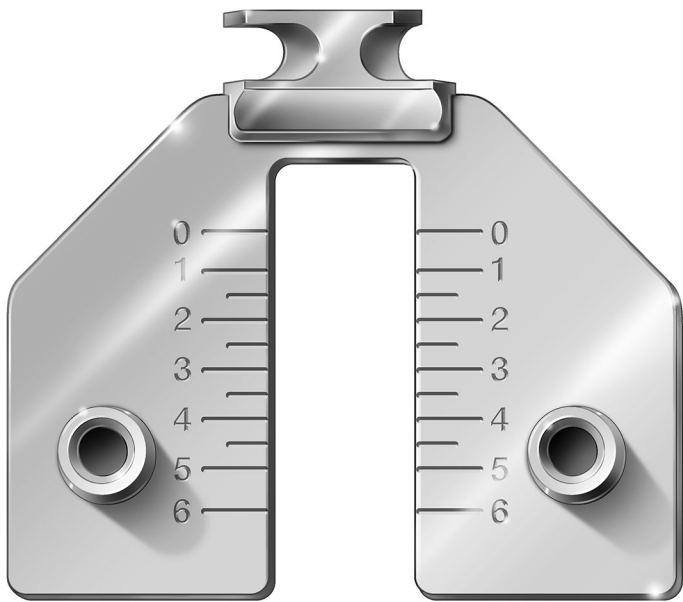

ligsta08.tif



ligsta10.tif

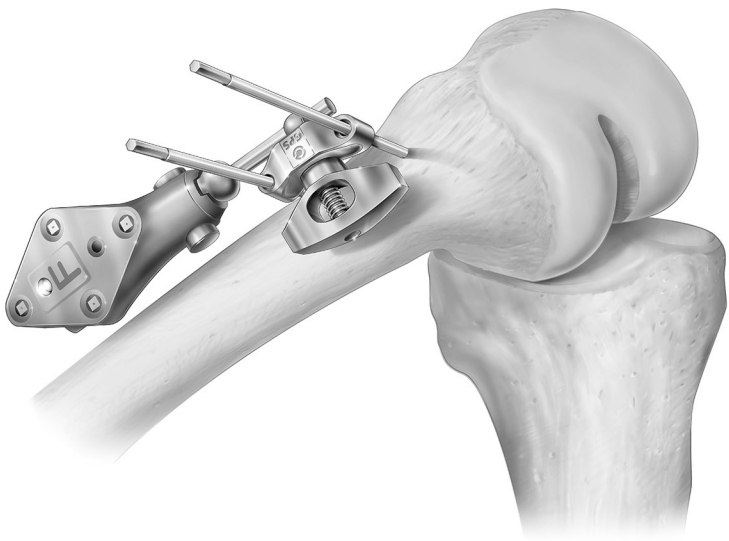

gpsrt01.tif

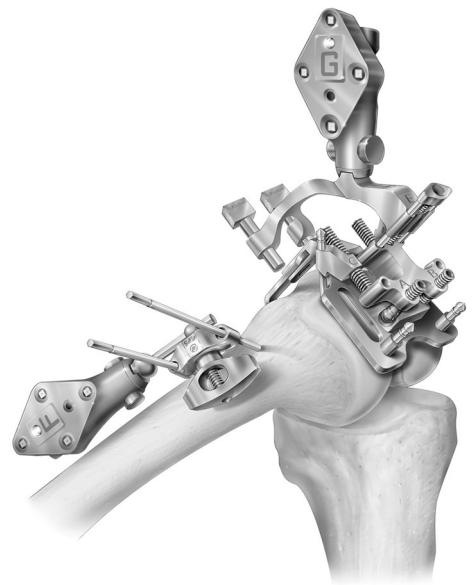

gpsrt02.tif

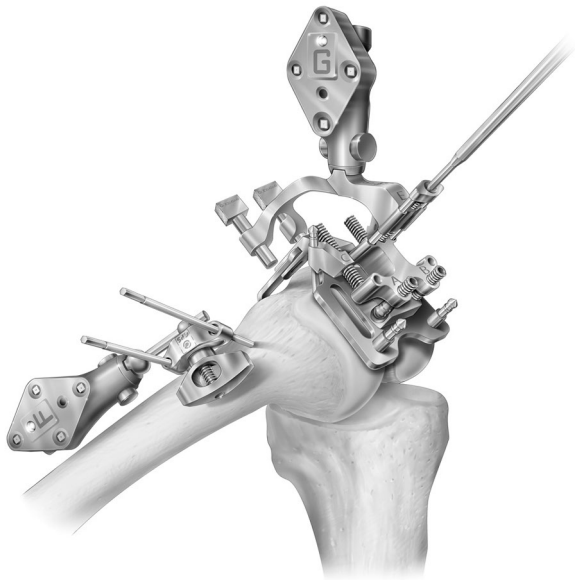

gpsrt03.tif

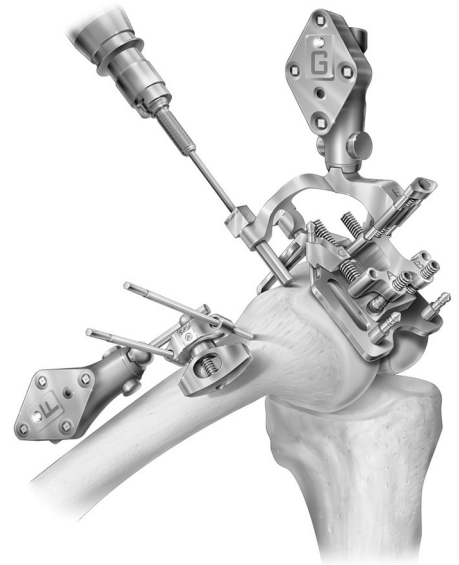

gpsrt04.tif

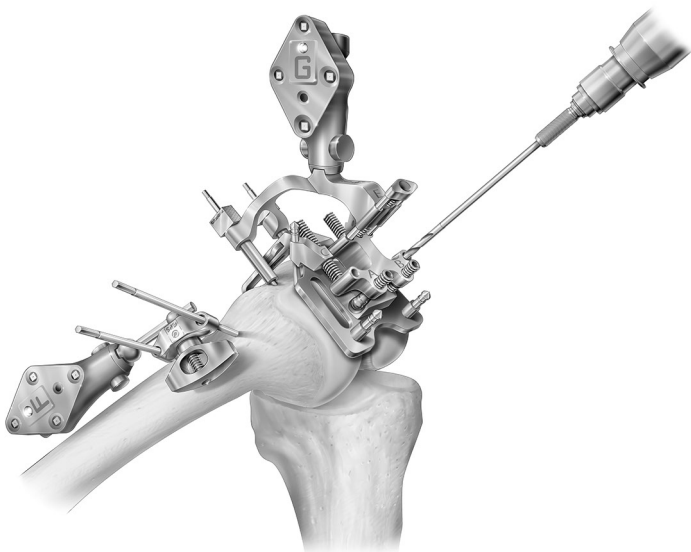

gpsrt05.tif

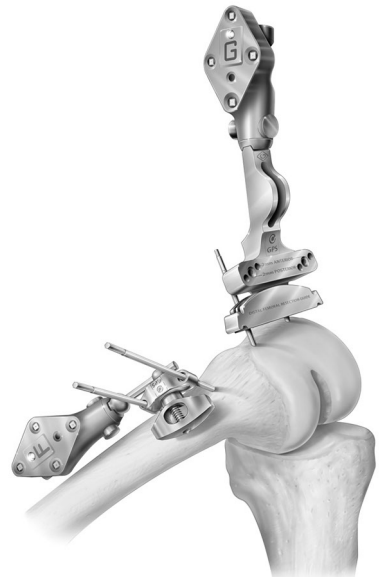

gpsrt06.tif

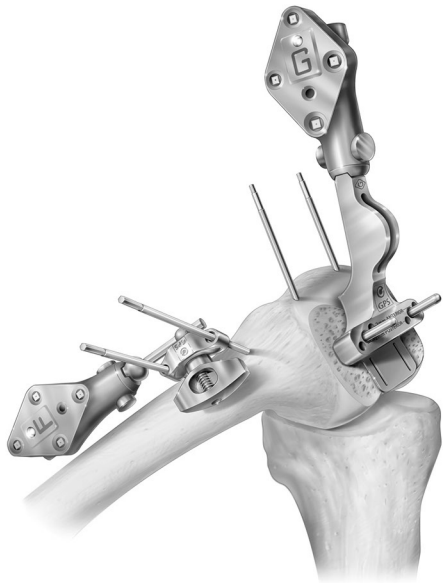

gpsrt07.tif

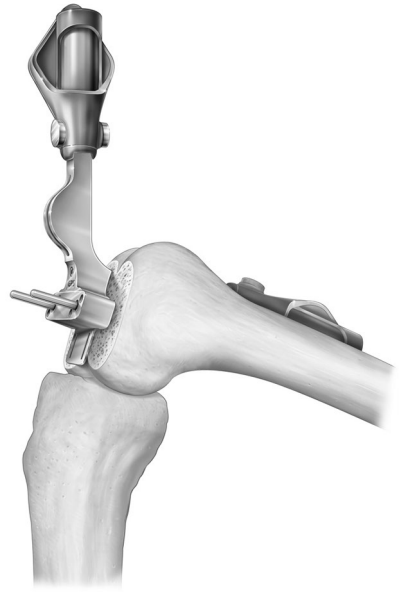

gpsrt09.tif

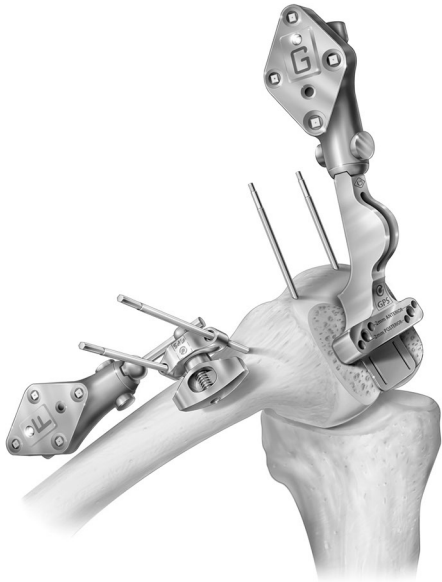

gpsrt10.tif

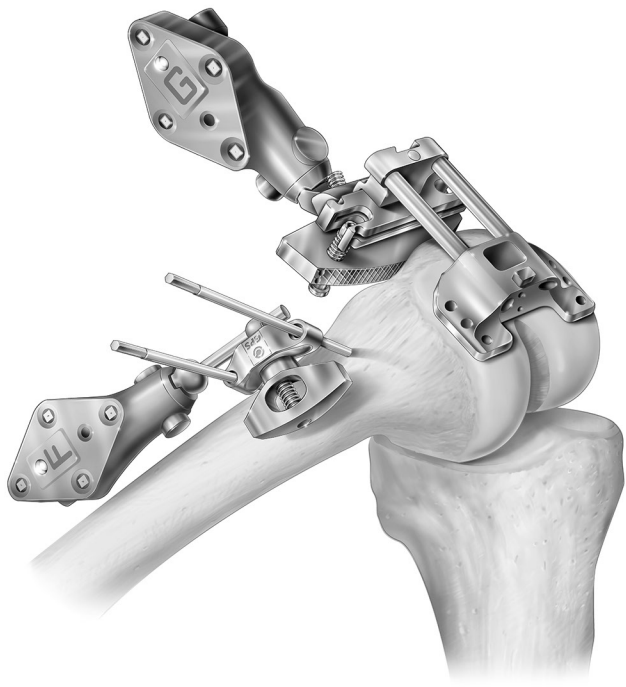

gpsadd01.tif

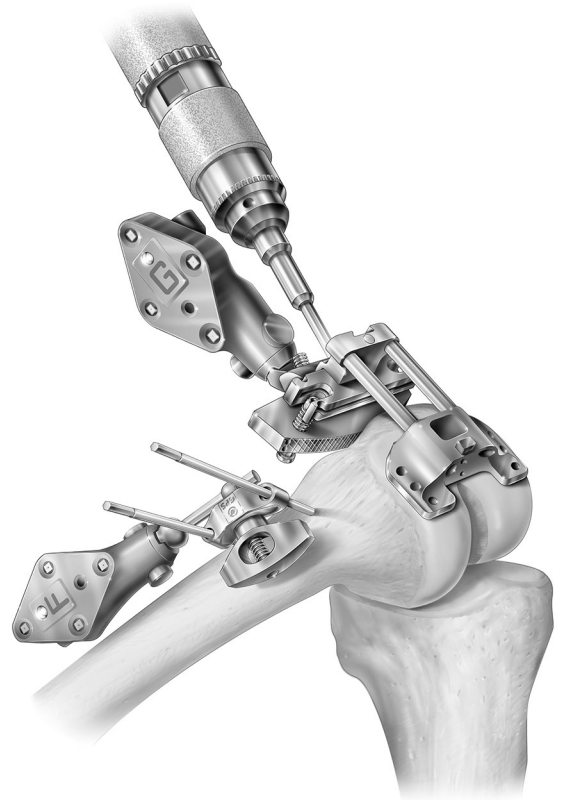

gpsadd02.tif

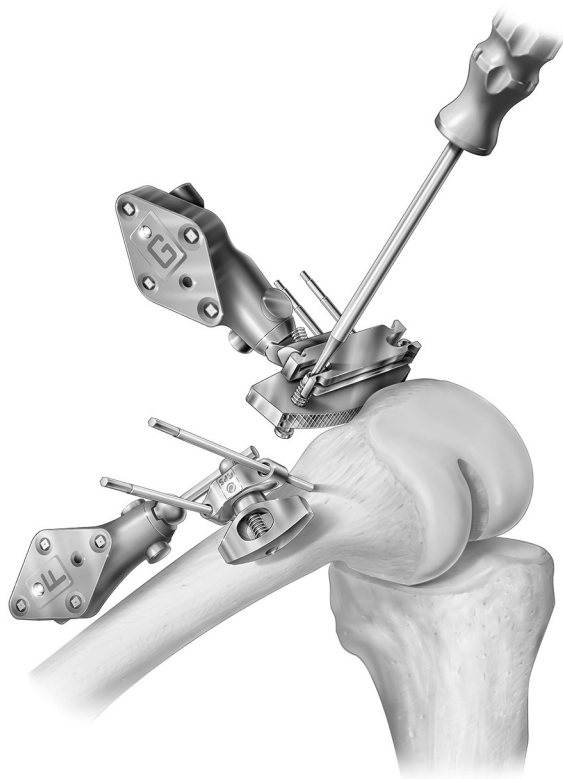

gpsadd03.tif

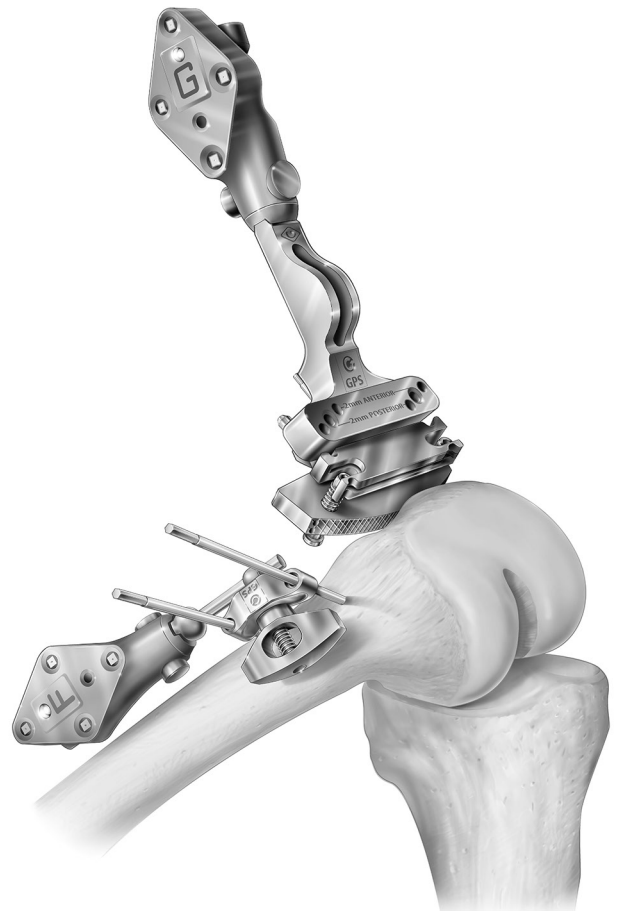

gpsadd04.tif

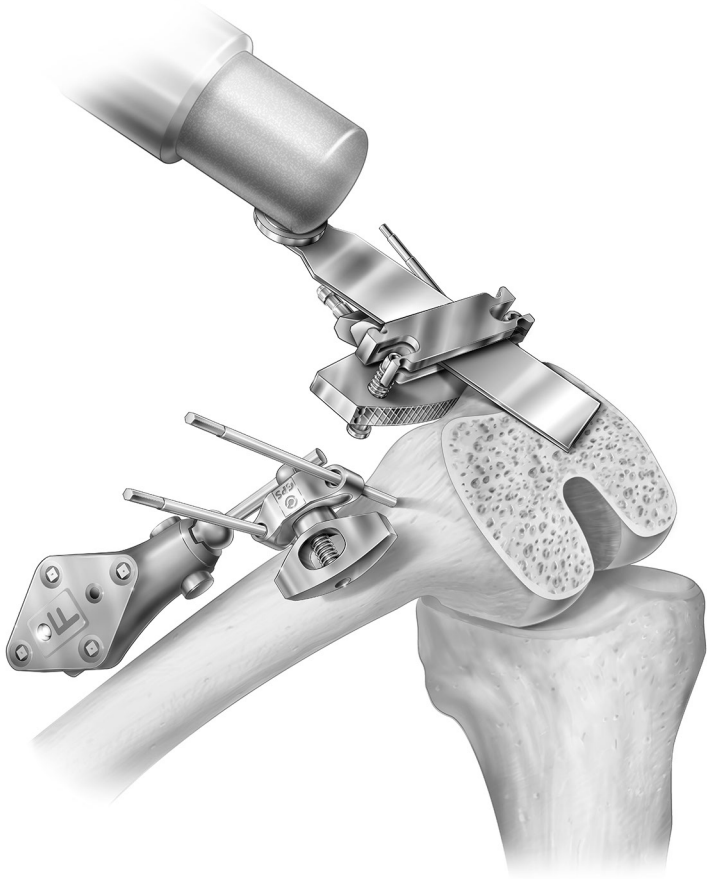

gpsadd05.tif

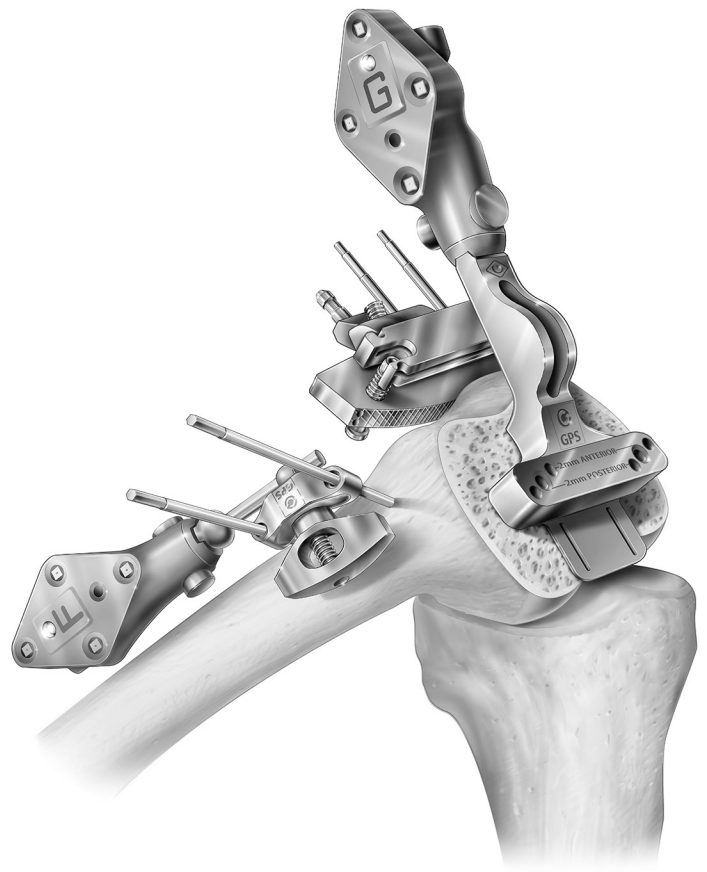

gpsadd06.tif

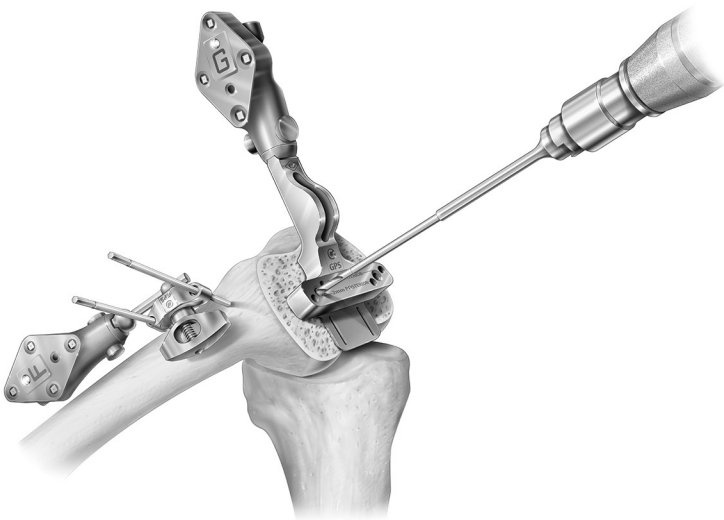

gpsadd07.tif

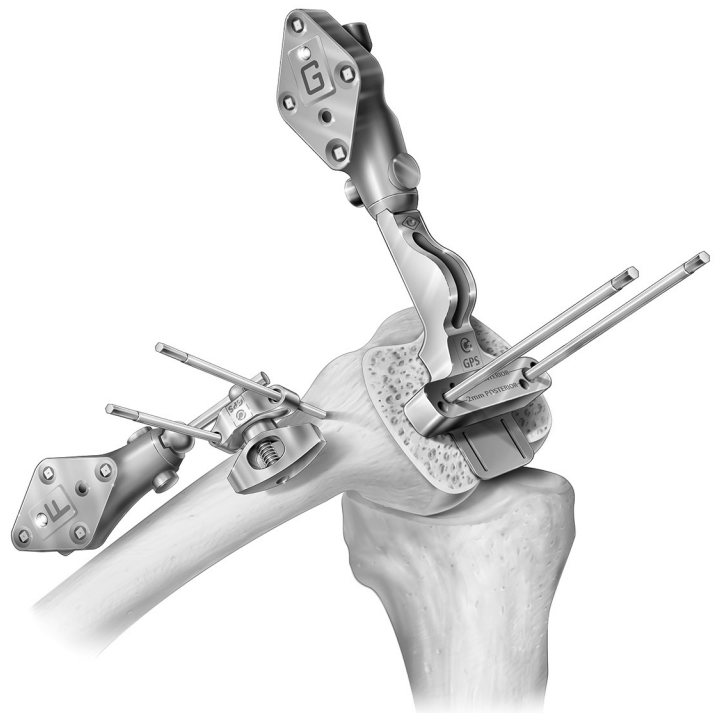

gpsadd08.tif